

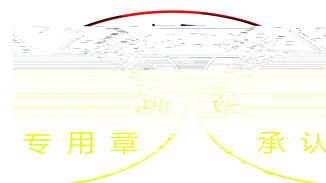
SPECIFICATION

REFOND P/N

RC35G1-RBD-FR

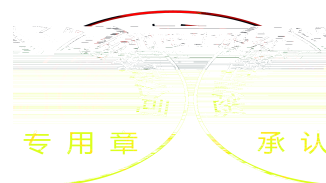
R&D

Mass Product



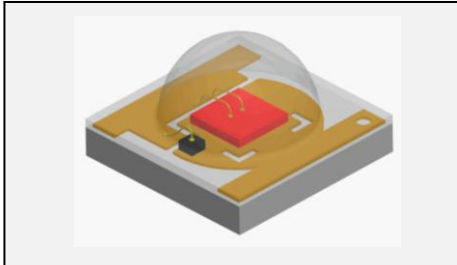
Contents

1. Description	3
1.1 General Description	3
1.2 Features	3
1.3 Application	3
1.4 Package Dimension	4
1.5 Product Parameters	5
1.6 Typical optical characteristics curves	6
2. Packaging	9
2.1 Packaging Specification	9
2.1.1 Carrier Tape Dimension	9
2.1.2 Reel Dimension	10
2.1.3 Label Form Specification	10
2.2 Moisture Resistant Packing	11
2.3 Cardboard Box	11
2.4 Reliability Test Items And Conditions	12
2.5 Criteria For Judging Damage	12
3. SMT Reflow Soldering Instructions SMT	13
3.1 SMT Reflow Soldering Instructions SMT	13
3.1.1 Soldering Iron	14
3.1.2 Repairing	14
3.1.3 Cautions	15
4. Handling Precautions	15
4.1 Handling Precautions	15



1. Description

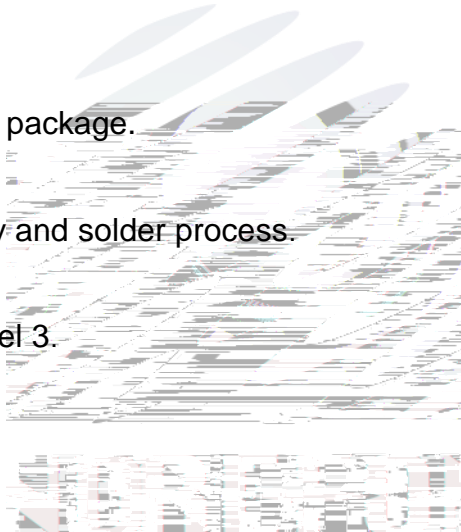
1.1 General Description



This production use the ceramics and Silicone molding package outline size 3.45X3.45X1.95mm

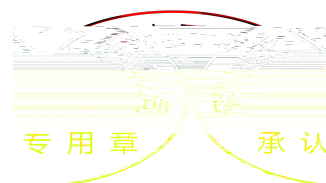
1.2 Features

- ▶ Ceramic and silicone molding package.
- ▶ Viewing angle:120°.
- ▶ Suitable for all SMT assembly and solder process.
- ▶ Available on tape and reel.
- ▶ Moisture sensitivity level: Level 3.
- ▶ RoHS compliant.



1.3 Application

- ▶ Flower production.
- ▶ Tissue culture.
- ▶ Plant factory.
- ▶ Refreshment.
- ▶ General use.



1.4 Package Dimension

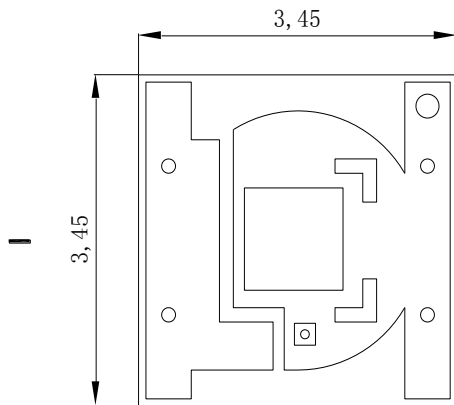


Fig.1-1 Top view

+

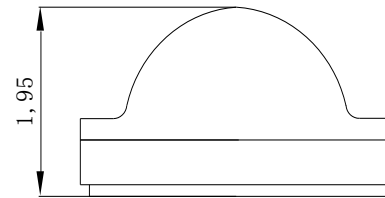


Fig.1-2 Side view

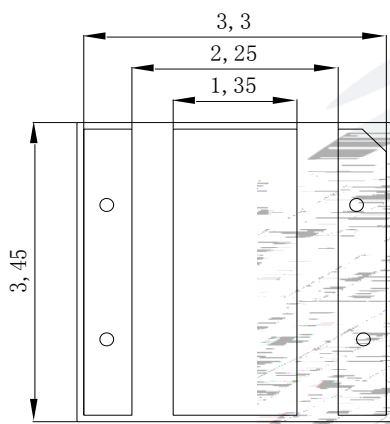


Fig.1-3 Bottom view

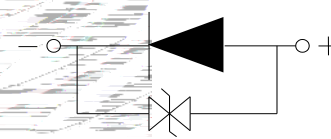


Fig.1-4 Polarity

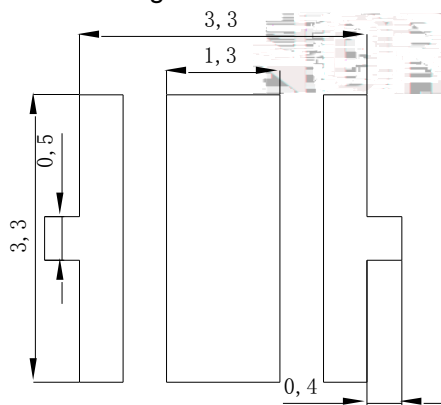
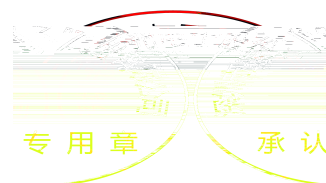


Fig.1-5 Soldering patterns

Notes:

1. All dimensions units are millimeters.
2. All dimensions tolerances are $\pm 0.2\text{mm}$ unless otherwise noted.



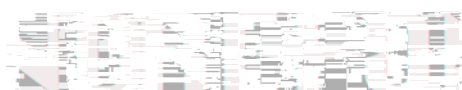
1.5 Product Parameters

Table 1-1 Electrical / Optical Characteristics at Ts=25°C

Item	Symbol	Test Condition	Value			Unit
			Min.	Typ	Max.	
Forward Voltage	V_F	$I_F=350\text{mA}$	1.8	2.2	2.6	V



Table 1-2 Absolute Maximum Ratings at Ts=25°C



Notes:

1. 1/10 Duty cycle, 0.1ms pulse width.
2. The above forward voltage measurement allowance tolerance is $\pm 0.1V$.
3. The above wavelength measurement allowance tolerance is $\pm 2nm$.
4. The above radiation flux measurement allowance tolerance $\pm 10\%$.
5. Care is to be taken that power dissipation does not exceed the absolute maximum rating of the product.
6. All measurements were made under the standardized environment of Refond.
7. When the LEDs are in operation the maximum current should be decided after measuring the package temperature, junction temperature should not exceed the maximum rate.
8. ESD yield is over 90% at 2000V ESD (HBM). ESD protection during products handing is needed.

1.6 Typical optical characteristics curves

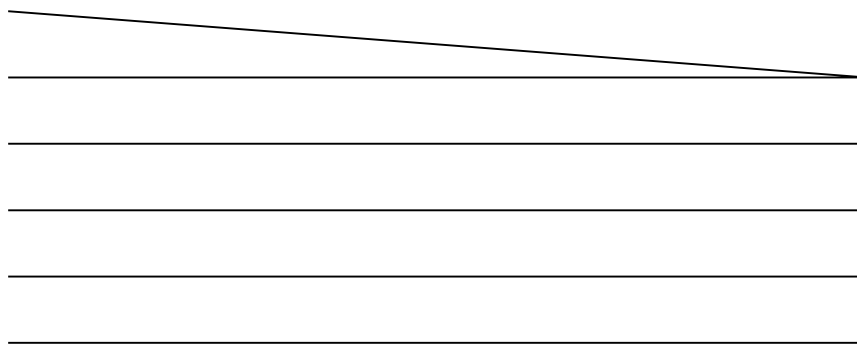


Fig.1- Forward Voltage Vs. Forward Current

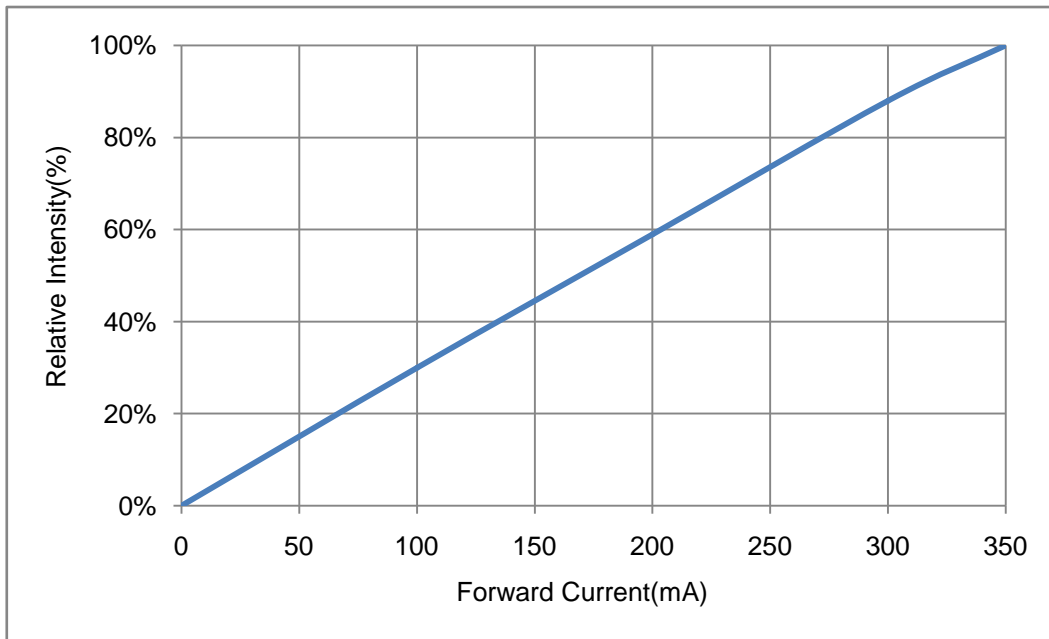


Fig.2- Forward Current Vs. Relative Power

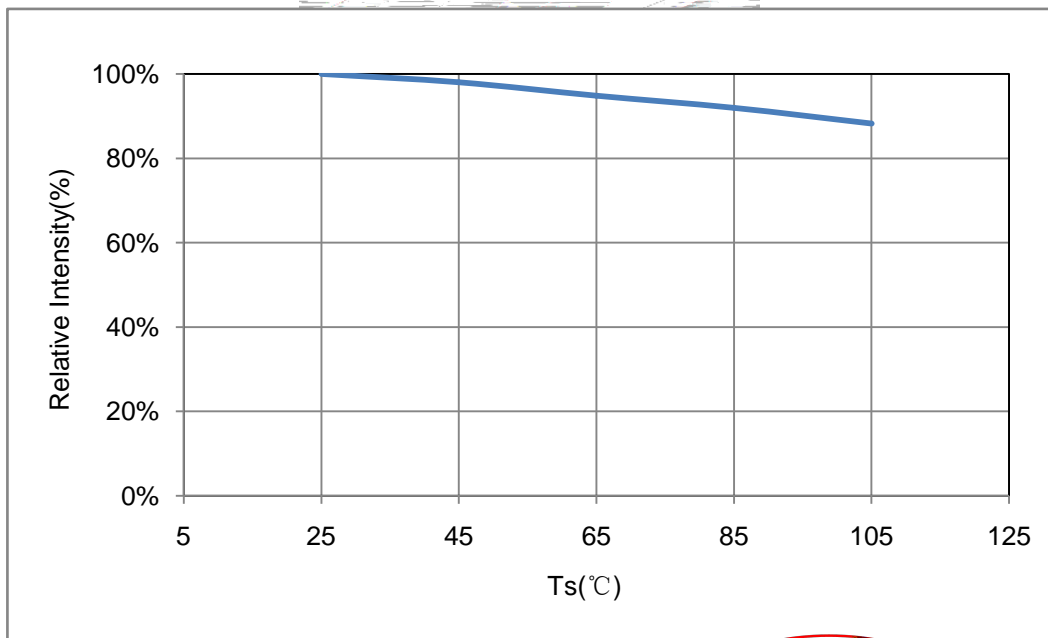
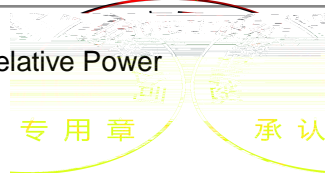


Fig.3-Solder Temperature VS. Relative Power



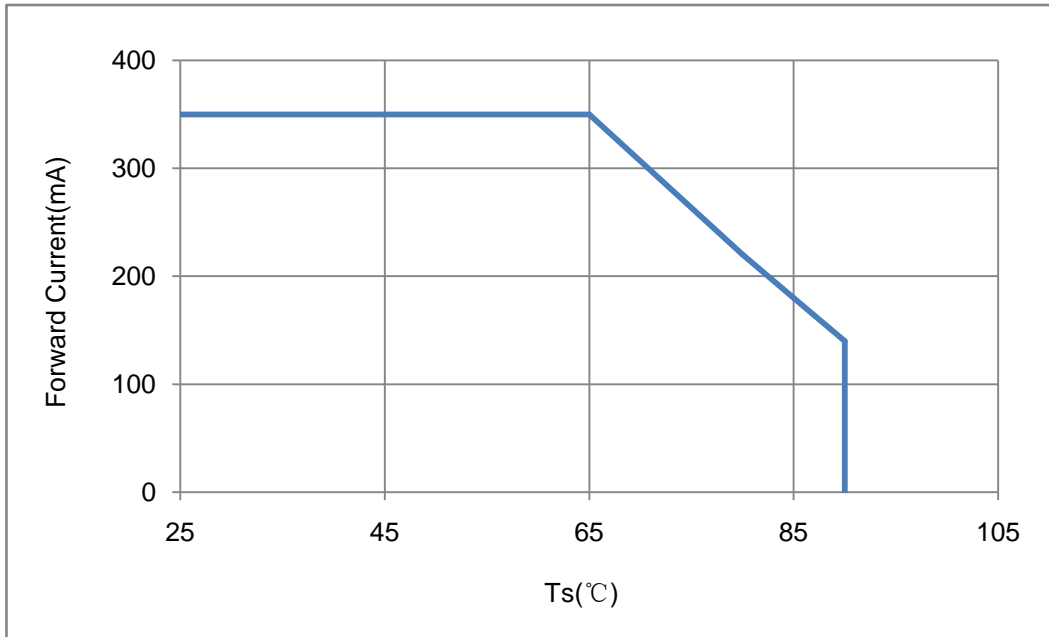


Fig.4-Ts Temperature VS. Forward Current

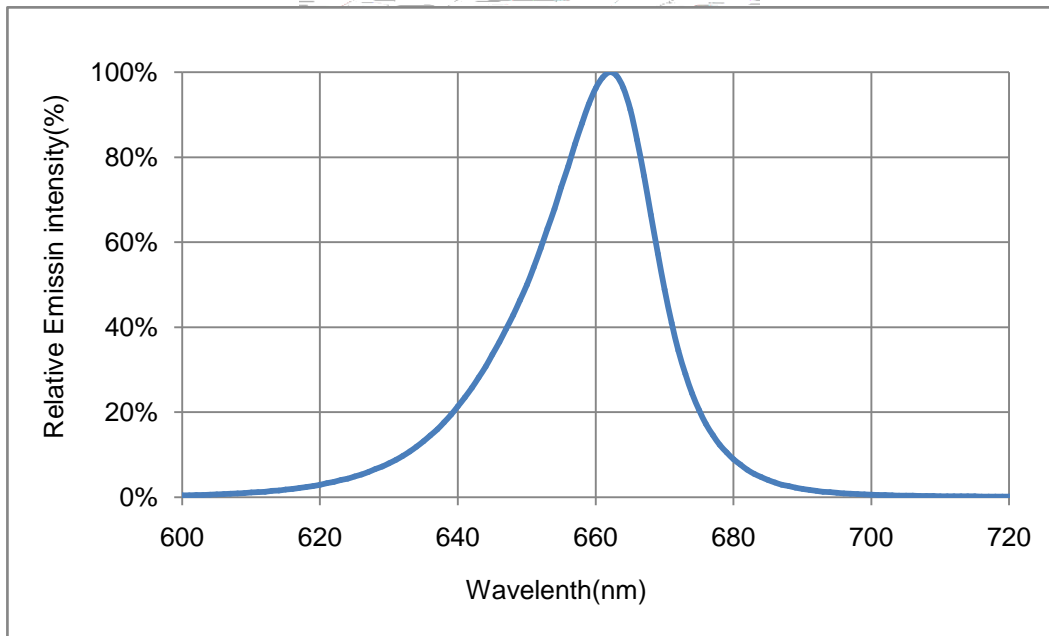
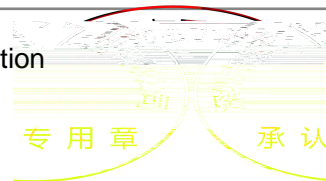


Fig.5-Spectrum Distribution



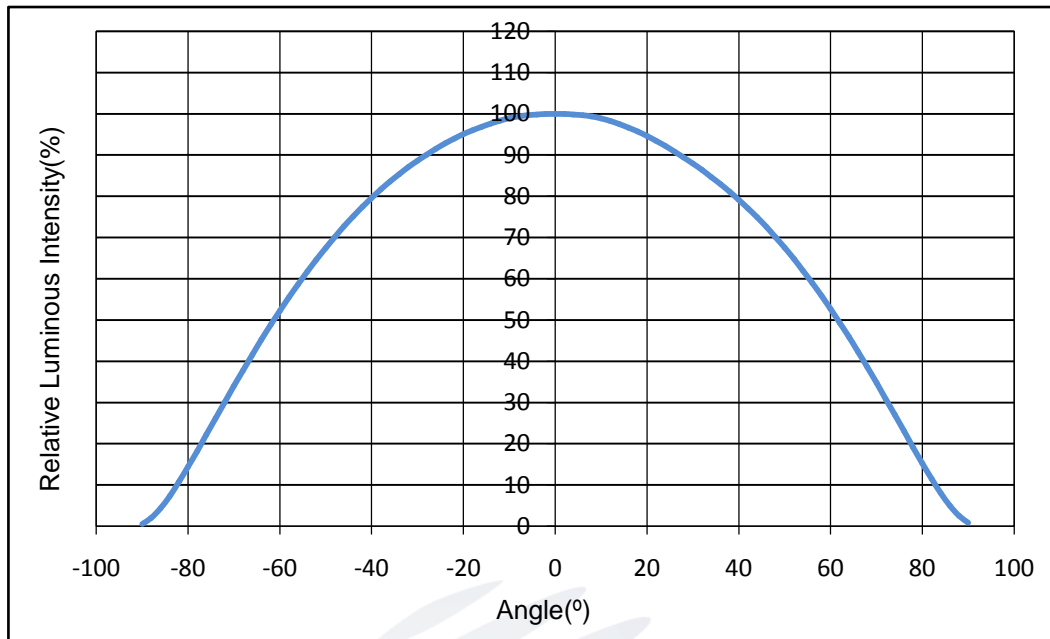


Fig.6- Radiation Diagram

2. Packaging

2.1 Packaging Specification

Package: 1000pcs/reel.

2.1.1 Carrier Tape Dimension

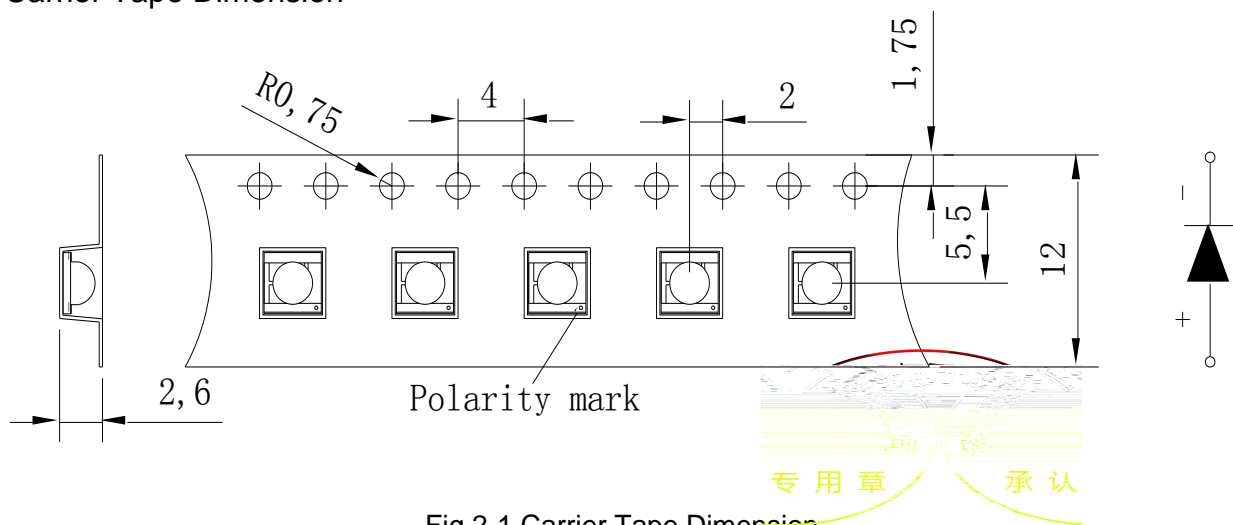
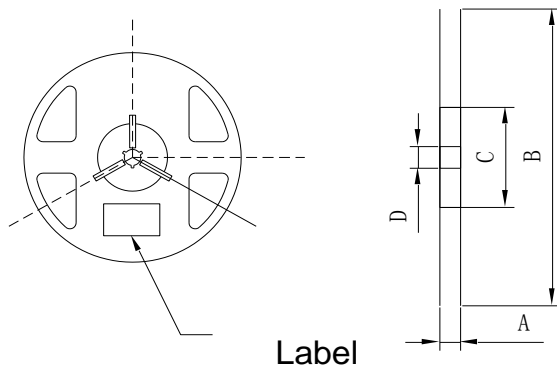


Fig.2-1 Carrier Tape Dimension

2.1.2 Reel Dimension

Table 2-1 Reel Dimension



A	12±0.1mm
B	178±1mm
C	60±1mm
D	13.0±0.5mm

Fig.2-2 Reel Dimension

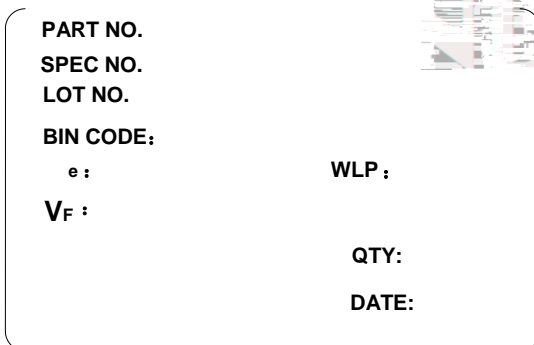
Notes:

The tolerances unless mentioned ±0.1mm. Unit : mm .

2.1.3 Label Form Specification

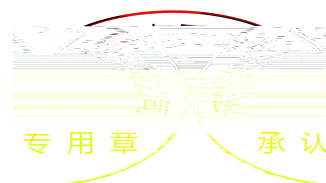


Table 2-2 Label Form Specification



PART NO.	Part Number
SPEC NO.	Spec Number
LOT NO.	Lot Number
BIN CODE	Bin Code
Φe	Radiation flux
V _F	Forward Voltage
WLP	Wavelength
QTY	Packing Quantity
DATE	Made Date

Fig. 2-3 Label Form Specification



2.2 Moisture Resistant Packing

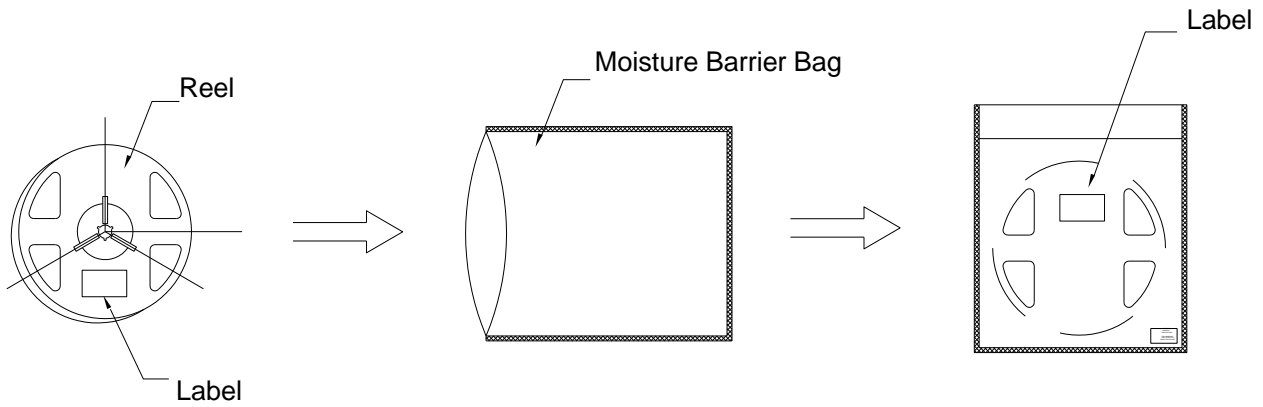


Fig.2-4 Moisture Resistant Packing Process

2.3 Cardboard Box

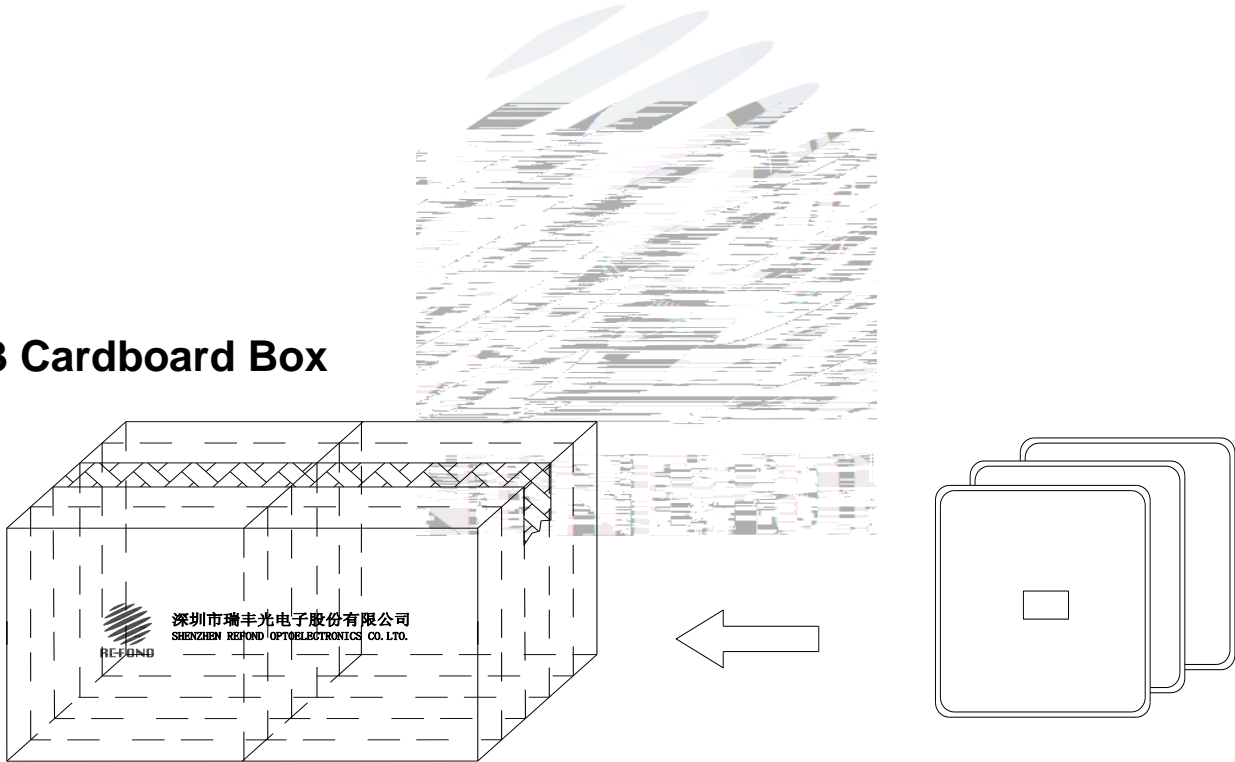
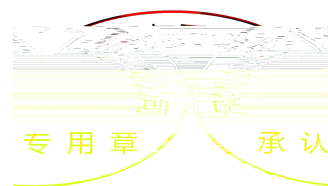


Fig.2-5 Cardboard Box



2.4 Reliability Test Items And Conditions

Table 2-3 Reliability Test Items And Conditions

Test Items	Ref.Standard	Test Condition	Time	Quantity	Ac/Re
Reflow	JESD22-B106	Temp:260°Cmax T=10 sec	3times.	10Pcs.	0/1
Temperature Cycle	JESD22-A104	100°C 30 min. ↑↓5 min -40°C 30 min.	300 Cycles	10Pcs.	0/1
Thermal Shock	JESD22-A106	-40°C 15min ↑↓10s 100°C 15min	300 Cycles	10Pcs.	0/1
High Temperature Storage	JESD22-A103	Temp:100°C	1000Hrs.	10Pcs.	0/1
Low Temperature Storage	JESD22-A119	Temp:-40°C	1000Hrs.	10Pcs.	0/1
Life Test	JESD22-A108	T _a =25°C I _F =350mA	1000Hrs.	10Pcs.	0/1

2.5 Criteria For Judging Damage

Table 2-4 Criteria For Judging Damage

Test Items	Symbol	Test Condition	Criteria For Judgement	
			Min.	Max.
Forward Voltage	V _F	I _F =350mA	-	U.S.L*)x1.1
Reverse Current	I _R	V _R = 5V	-	U.S.L*)x2.0
Total radiant flux	Φ _e	I _F =350mA	L.S.L*)x0.7	-

Notes:

1. U.S.L: Upper standard leve. L.S.L: Lower standard level.
2. The above reliability tests is based on the verification of a single/strip LED of Refond's existing experimental platform,



Table 3-1 SMT Reflow Soldering Instructions SMT

Average temperature rise speed (T _{max})	Max 3 °C/ s
Preheating: minimum temperature (T _{min})	150 °C
Preheating: Max temperature (T _{max})	200 °C
Preheating: Time (T _{min} -T _{max})	60s-120s
Time limited to maintain high temperature: the temperature (T _L)	217 °C
Time limited to maintain high temperature: The Time (t _L)	Max 60s
Peak /Classification of temperature: (T _P)	260 °C
Time limit classification of peak temperature time (t _p)	Max 10s
Hold time within 5 °C with the actual peak temperature (T _P)	Max 30s
Cooling speed	Max 6 °C/ s
Needed time from 25 °C to T _p	Max 8 minutes

Notes:

- (1) Reflow soldering should not be done more than twice. If more than 24 hours between the two solderings , LED will be damaged.
- (2)When soldering , do not put stress on the LEDs during heating.

3.1.1 Soldering Iron

- (1) When do soldering by hand, keep the temperature of iron below less 300 less than 3 seconds.
- (2) Soldering by hand should be done only one time.

3.1.2 Repairing

Repairing should not be done after the LEDs have been soldered. When repairing is unavoidable,a double-head soldering iron should be used (as below figure). It should be confirmed in advance whether the characteristics of LEDs will or not be damaged by repairing.



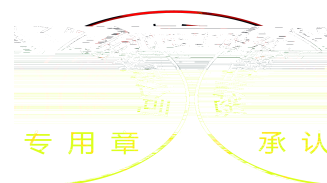
3.1.3 Cautions

- (1) The encapsulated material of the LEDs is silicone. Therefore the LEDs have a soft surface on the top of package. The pressure to the top surface will be impacted on the reliability of the LEDs. Precautions should be taken to avoid the strong pressure on the encapsulated part. So when use the picking up nozzle, the pressure on the silicone resin should be proper.
- (2) Components should not be mounted on warped (non coplanar) portion of PCB. After soldering, do not warp the circuit board.
- (3) Do not apply mechanical force or excess vibration during the cooling process to normal temperature after soldering. Do not rapidly cool device after soldering.

4. Handling Precautions

4.1 Handling Precautions

- (1) LED operating environment and sulfur element composition cannot be over 100PPM in the LED mating usage material. This is provided for informational purposes only and is not a warranty or endorsement.
- (2) In order to prevent external material from getting into the inside of LED, which may cause the malfunction of LED, the single content of Bromine element is required to be less than 900PPM, the single content of Chlorine element is required to be less than 900PPM, the total content of Bromine element and Chlorine element in the external materials of the application products is required to be less than 1500PPM. This is provided for informational purposes only and is not a warranty or endorsement.
- (3) VOCs (Volatile organic compounds) emitted from materials used in the construction of fixtures can penetrate silicone encapsulants of LEDs and discolor when exposed to heat and photonic energy. The result can be a significant loss of light output from the fixture. Knowledge of the properties of the materials selected to be used in the construction of fixtures can help prevent these issues. Refond advises against the use of any chemicals or materials that have been found or are suspected to have an adverse effect on device performance or reliability. To verify compatibility, Refond recommends that all chemicals and materials be tested in the specific application and environment for which they are intended to be used. Attaching LEDs, do not use adhesives that outgas organic vapor.



(4) Handle the component along the side surface by using forceps or appropriate tools; Do not directly touch or Handle the silicone lens surface, it may damage the internal circuitry.

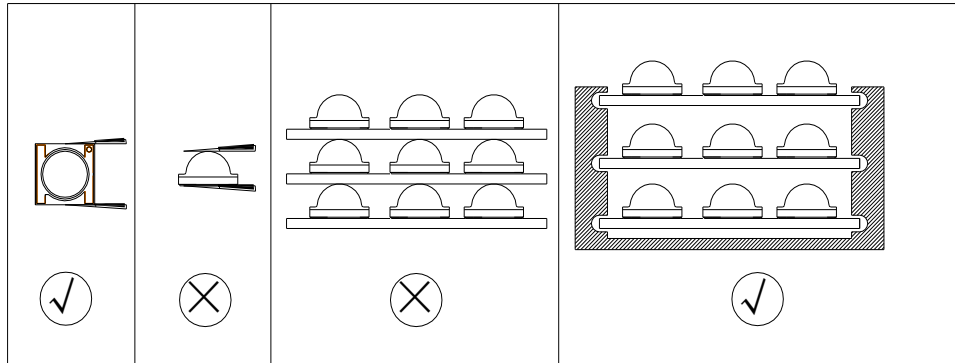


Fig 4-1 Operate Method

(5) In designing a circuit, the current through each LED can not exceed the absolute maximum rating specified for each LED. In the meanwhile, resistors for protection should be applied, otherwise slight voltage shift will cause big current change, burn out may happen. The driving circuit must be designed to allow forward voltage only when it is ON or OFF. If the reverse voltage is applied to LED, migration can be generated resulting in LED damage.

(6) Thermal Design is paramount importance because heat generation may result in the Characteristics decline, such as brightness decreased, Color change and so on. Please consider the heat generation of the LEDs when making the system design.

(7) Compared to standard encapsulants, silicone is generally softer, and the surface is more likely to attract dust, requiring special care during processing. In cases where a minimal level of dirt and dust particles cannot be guaranteed, a suitable cleaning solution must be applied to the surface after the soldering of components. Refond suggests using isopropyl alcohol for cleaning. In case other solvents are used, it must be assured that these solvents do not dissolve the package or resin. Ultrasonic cleaning is not recommended. Ultrasonic cleaning may cause damage to the LED.

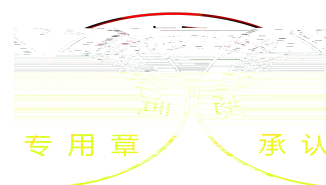


Table 4-1 Storage

Conditions		Temperature	Humidity	Time
Storage	Before Opening Aluminum Bag	$\leq 30^{\circ}\text{C}$	$\leq 75\%$	Within 1 Year From Date
	After Opening Aluminum Bag	$\leq 30^{\circ}\text{C}$	$\leq 60\%$	24hours
Baking		$60 \pm 5^{\circ}\text{C}$	-	$\geq 24\text{hours}$

(8) If the moisture absorbent material silica gel has faded away or the LEDs have exceeded the storage time, baking treatment should be performed after unpacking and based on the following condition $65 \pm 5^{\circ}\text{C}$ for above 24 hours.

If the package is flatulence or damaged, please notify the sales staff to assist.

(9) Similar to most Solid state devices, LEDs are sensitive to Electro-Static Discharge (ESD) and Electrical Over Stress (EOS).

(10) Other points for attention, please refer to our relevant information.

