

SPECIFICATION

REFOND P/N

RF-MTD**2T08-E1

Mass Product

Contents

1. LED Module Description	
2.LED Module Specification	
2.1 Optical-electrical Characteristics(Absolute Maximum Ratings At Ts=25)	. 4
2.2 LED Module Schematic And Interface Definition 6
2.3 LED Module rule of naming	: 6
3. Product Specification	
3.1 Outline Dimension 7
4. LED Module Reliability Test	
5. LED Module Materials Performance Test And Method At Ta=25	
6.Packing Criterion	
6.1 Package Diagram / 10
6.2 Blister box Dimensions/ 10
6.3 Carton Dimensions/ 10
6.4 Carton silk printing/ 11
6.5 Label Form Specification/ 11
7. Handling Precautions	

1. LED Module Description

LED Module designed according to the market mainstream of lamps and lanterns, easy to match, assembly is convenient;

LED Module with high reliability and high safety;

LED Module use 2835 LED Package, high lighting efficiency, low heat, without Mercury, belong to the environmental protection cold light source;

LED Module electrical parameter design in line with the market mainstream LED power supply, easy to match, the assembly is convenient

LED Module with lower thermal resistance and good heat dissipation;

High CRI , Color temperature more selective.

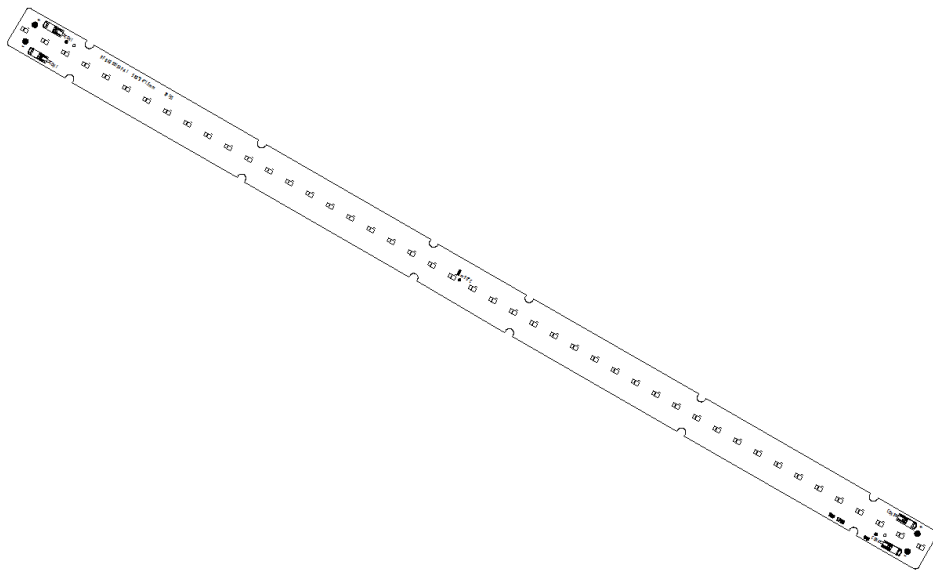

2.LED Module Specification

2.1 Optical-electrical Characteristics(Absolute Maximum Ratings At Ts=25)

Tab.2-1 Optical-electrical Characteristics

Refond PN

Absolute Maximum Ratings at Ts=25°C

Parameter	Symbol	Rating	Units
Forward Current	I _F	180	mA
Peak Forward Current	I _{FP}	450	mA
Reverse Voltage	V _R	5	V
Electrostatic Discharge	E _{SD}	2000	V

Operating Temperature (T_e) 80

2.2 LED Module Schematic And Interface Definition

Fig.2-2ED Module connection

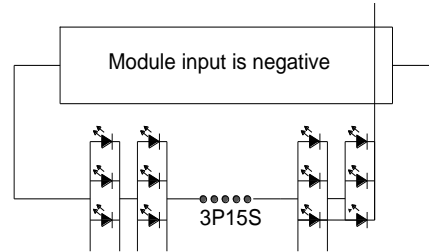

2.3 LED Module rule of naming

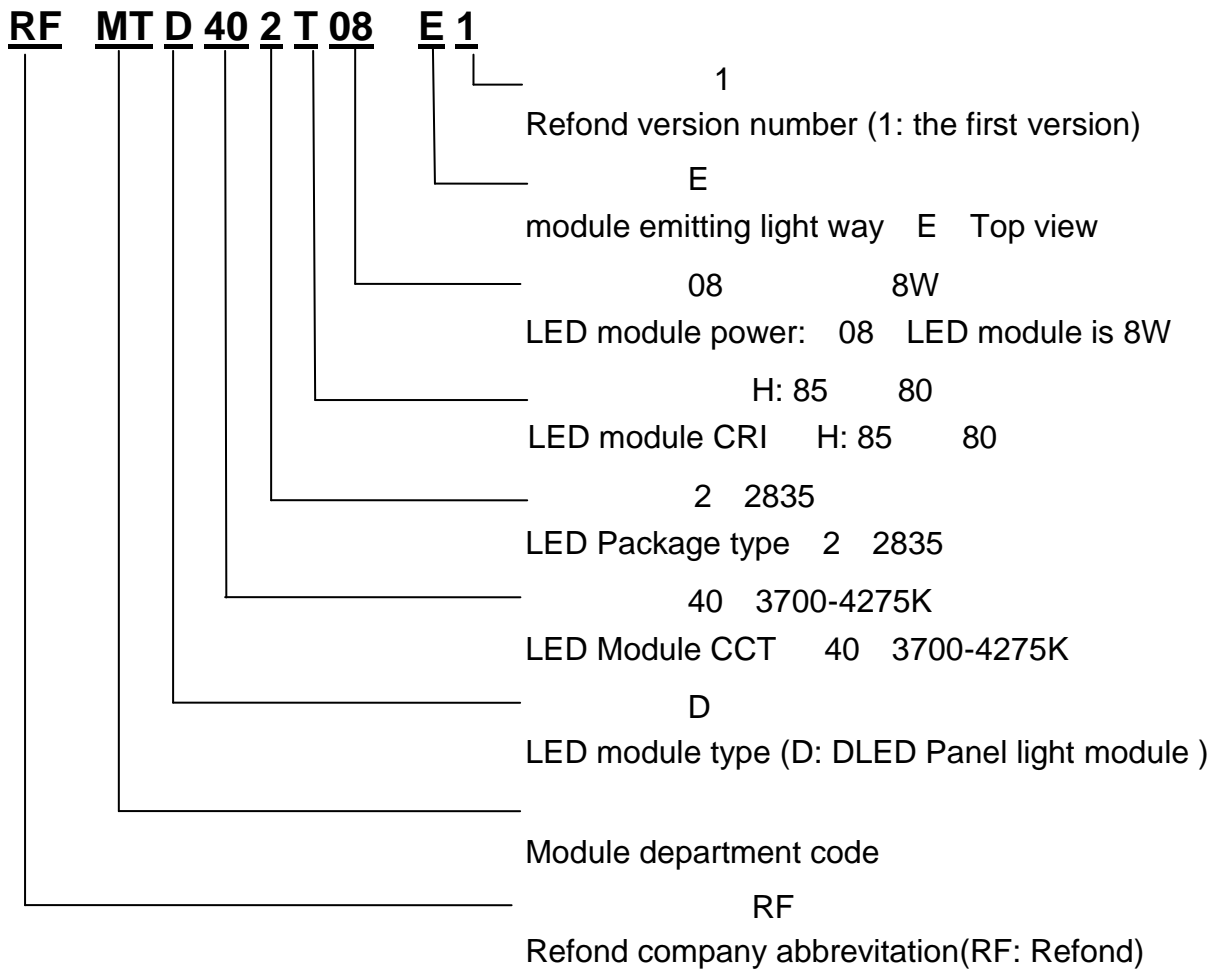

3. Product Specification

3.1 Outline Dimension

4. LED Module Reliability Test

Tab 4-1 Light Bar Reliability Test

Test Item/	Test Conditions/	Test Time/	Number Of Test/	Judgement Criterions/
Operating Life At Room Temperature/	$T_A=25$ $I_F=180\text{mA}$ $T_J<115$	500Hrs	0/6	1. $V_f<110\%$, $\text{CIE } x/ y<0.015$ 2.No catastrophic failure
Operating Life At High Temperature/	$T_A=60$ $I_F=180\text{mA}$ $T_J<115$	500Hrs	0/6	
Operating Life At High Temperature And Humidity/	60 $R_H=90\%$ $I_F=180\text{mA}$ $T_J<115$	500Hrs	0/6	
Thermal Shock/	-40 15min 85 15min	100 cycle	0/6	No Dead LED

Notes

voltage distribution, heat dissipation and others.

5. LED Module Materials Performance Test And Method At Ta=25

Tab 5-1 Light Bar Materials Performance Test And Method Ta=25

Test Item	Test Conditions	Test Methods
LED Optical-electrical Characteristics LED	Compliance With Specifications/	In(i)-4 Tf1 0 0 1 260.f1 0*

6.Packing Criterion

6.1 Package Diagram /

Fig 8-1 Package Diagram /

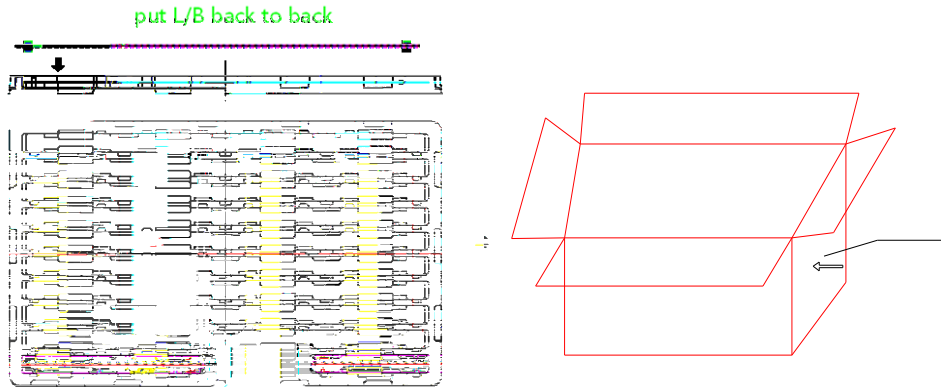

6.2 Blister box Dimensions/

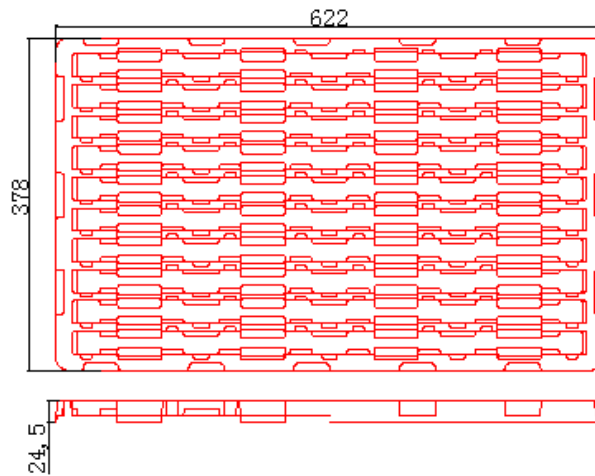

6.3 Carton Dimensions/

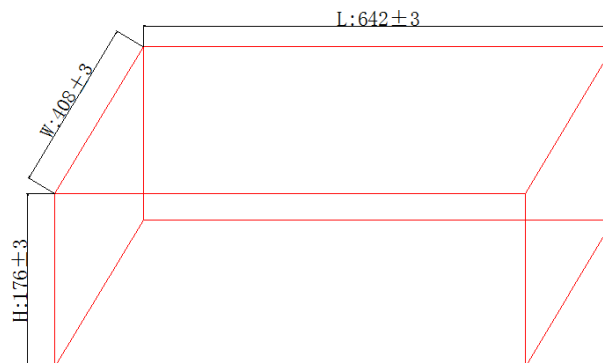

6.4 Carton silk printing/

REFOND LOGO Pay attention to identify

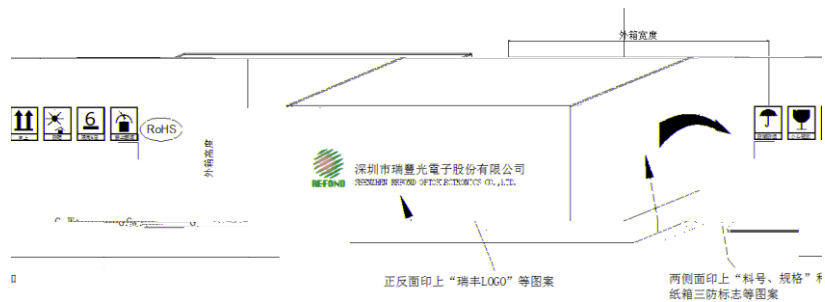

6.5 Label Form Specification/



customer PN			
/P.N			
/BIN CODE		/LM	
/VF		/CCT	
		/QTY	
/N.W		/DATE	

Package quantity(160PCS/carton)

1. A box of 9 plastic boxes, including 8 plastic ones, has an empty one which is used as a cover to protect the modules underneath.

2. Plastic boxes should be put layer by layer with a positive and negative layer stacked together ,a total of 8 layers, and a layer of empty plastic box as protection one is supposed to be put on the top.

3. Each plastic box has a total of 20PCS module installed and contains 10 slots, in which 2PCS module should be put back to back.

The cartons of the whole box can be subjected to six layers. As for the height of the stack , please make decision based on the actual situation.

7. Handling Precautions

(1) LED operating environment and sulfur element composition cannot be over 100PPM in the LED mating usage material. This is provided for informational purposes only and is not a warranty or endorsement. LED

(2) In order to prevent external material from getting into the inside of LED, which may cause the malfunction of LED, the single content of Bromine element is required to be less than 900PPM, the single content of Chlorine element is required to be less than 900PPM, the total content of Bromine element and Chlorine element in the external materials of the application products is required to be less than 1500PPM. This is provided for informational purposes only and is not a warranty or endorsement.

(3) VOCs (Volatile organic compounds) emitted from materials used in the construction of fixtures can penetrate silicone encapsulants of LEDs and discolor when exposed to heat and photonic energy. The result can be a significant loss of light output from the fixture. Knowledge of the properties of the materials selected to be used in the construction of fixtures can help prevent these issues. Refond advises against the use of any chemicals or materials that have been found or are suspected to have an adverse affect on device performance or reliability. To verify compatibility, Refond recommends that all chemicals and materials be tested in the specific application and environment for which they are intended to be used. Attaching LEDs, do not use adhesives that outgas organic vapor.

(4) Handle the component along the side surface by using forceps or appropriate tools; do not directly touch or Handle the silicone lens surface, it may damage the internal circuitry.

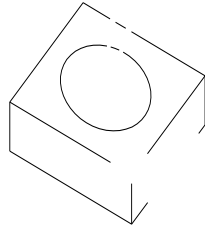

(5) In designing a circuit, the current through each LED can not be exceed the absolute maximum rating specified for each LED. In the mean while, resistors for protection should be applied, otherwise slight voltage shift will cause big current change, burn out may happen. The driving circuit must be designed to allow forward voltage only when it is ON or OFF. If the reverse voltage is applied to LED, migration can be generated resulting in LED damage.

(6) Thermal Design is paramount importance because heat generation may result in the Characteristics decline, such as brightness decreased, Color change and so on. Please consider the heat generation of the LEDs when making the system design.LED

(7) Compared to standard encapsulants, silicone is generally softer, and the surface is more likely to attract dust , requiring special care during processing. In cases where a minimal level of dirt and dust particles cannot be guaranteed, a suitable cleaning solution must be applied to the surface after the soldering of components. Refond suggests using isopropyl alcohol for cleaning. In case other solvents are used, it must be assured that these solvents do not dissolve the package or resin. Ultrasonic cleaning is not recommended. Ultrasonic cleaning may cause

damage to the LED.

(8) Similar to most Solid state devices; LEDs are sensitive to Electro-Static Discharge (ESD) and Electrical Over Stress (EOS).

9>.NO warping or twisting the Light Bar more than 10°. Forbidding holding the LED part or connector part when handling.



(10) Other points for attention, please refer to our relevant information.

Version History/

Date	Revisor	Version	Verifier	Remarks
2021-08-10		E/1		The first edition



Declare

This specification is written both in English and in Chinese and the latter is formal.