

SPECIFICATION

LT P/N

LT3004WH-A-Q

R&D

Mass Product

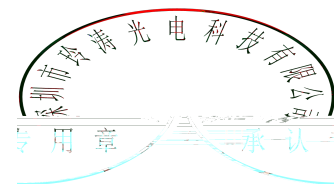

Contents

| | |
|---|-----|
| 1. Description | |
| 1.1 General Description | |
| 1.2 Features | |
| 1.3 Application | |
| 1.4 Package Dimension | |
| 1.5 Product Parameters | |
| 1.6 Bin Range Of Forward Voltage and Luminous Intensity (IF=20mA) | BIN |
| (IF=20mA) | |
| 1.7 Typical Optical Characteristics Curves | |
| 2. Packaging | |
| 2.1 Packaging Specification | |
| 2.1.1 Carrier Tape Dimension | 11 |
| 2.1.2 Reel Dimension | 11 |
| 2.1.3 Label Form Specification | 12 |
| 2.2 Moisture Resistant Packing | |
| 2.3 Cardboard Box | |
| 2.4 Reliability Test Items And Conditions | |
| 2.5 Criteria For Judging Damage | |
| 3. SMT Reflow Soldering Instructions SMT 回流焊说明 | |
| 3.1 SMT Reflow Soldering Instructions SMT | |
| 4. Handling Precautions | |
| 4.1 Handling Precautions | |

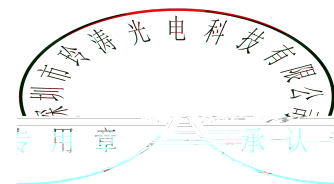

1. Description

1.1 General Description

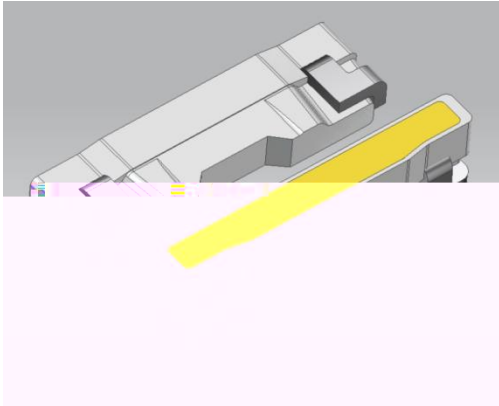

The White LED, which was fabricated by using a blue chip and the phosphor.

Product Package: 3.0mmX0.85mmX0.42mm.

LED, : 3.0mmX0.85mmX0.42mm

1.2 Features

PLCC Package. PLCC

Wide viewing angle.

Suitable for all SMT assembly and solder process. SMT

Available on tape and reel.

Moisture sensitivity level: Level 3. Level 3

RoHS compliant. RoHS

1.3 Application

LCD Back Light. LCD

Mobile Phones.

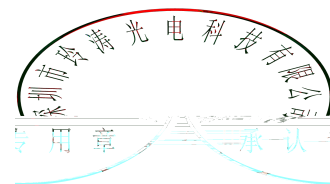
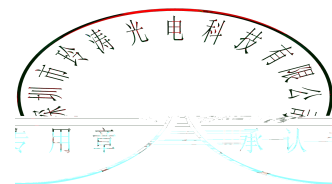

Table 1



1.6 Bin Range Of Forward Voltage and Luminous Intensity (IF=20mA)

BIN (IF=20mA)

Table 1-3 Bin Range Of Luminous Intensity Bin (IF=20mA)

| BIN CODE | IF=20mA Test | | | |
|----------|--------------|----------|---------|---------|
| | Min(mcd) | Max(mcd) | Min(lm) | Max(lm) |
| 30 | 2150 | 2250 | 6.00 | 6.25 |
| 31 | 2250 | 2350 | 6.25 | 6.50 |
| 32 | 2350 | 2450 | 6.50 | 6.75 |
| 33 | 2450 | 2550 | 6.75 | 7.00 |
| 34 | 2550 | 2650 | 7.00 | 7.25 |
| 35 | 2650 | 2750 | 7.25 | 7.50 |
| 36 | 2750 | 2850 | 7.50 | 7.75 |
| 37 | 2850 | 2950 | 7.75 | 8.00 |
| 38 | 2950 | 3050 | 8.00 | 8.25 |
| 39 | 3050 | 3150 | 8.25 | 8.50 |
| 40 | 3150 | 3250 | 8.50 | 8.75 |
| 41 | 3250 | 3350 | 8.75 | 9.00 |
| 42 | 3350 | 3450 | 9.00 | 9.25 |
| 43 | 3450 | 3550 | 9.25 | 9.5 |
| 44 | 3550 | 3650 | 9.5 | 9.75 |
| 45 | 3650 | 3750 | 9.75 | 10.0 |

Table 1-4 Bin Range Of Forward Voltage Bin

| BIN CODE | Min. | Max. | Unit | Condition |
|----------|------|------|------|-----------|
| V0 | 2.7 | 2.8 | V | IF=20mA |
| V1 | 2.8 | 2.9 | | |
| V2 | 2.9 | 3.0 | | |
| V3 | 3.0 | 3.1 | | |
| V4 | 3.1 | 3.2 | | |
| V5 | 3.2 | 3.3 | | |

Notes

VF Tolerance: $\pm 0.03V$ @ IF= 20mA @ Ta=25°C

IV Tolerance: $\pm 3\%$ @ IF= 20mA @ Ta=25°C

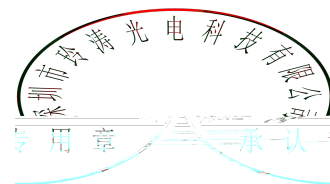

Fig. 1-5 The C.I.E. 1931 Chromaticity Diagram: ()

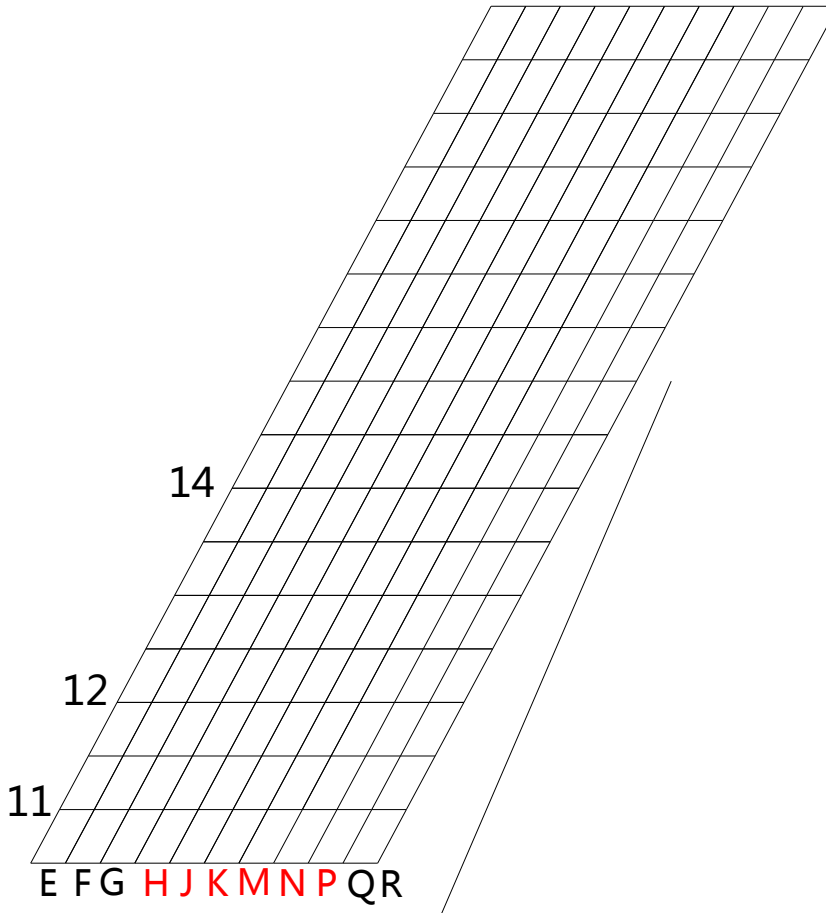

Table 1-6 Bin Range of Chromaticity Coordinates Block (IF=20mA ; Ta=25)

| | | | | | | | | | | | | | | | | | |
|------|--------|--------|------|--------|--------|------|--------|--------|------|--------|--------|------|--------|--------|------|--------|--------|
| H11X | 0.2302 | 0.1944 | J11X | 0.2354 | 0.1944 | K11X | 0.2406 | 0.1944 | M11X | 0.2458 | 0.1944 | N11X | 0.2510 | 0.1944 | P11X | 0.2562 | 0.1944 |
| | 0.2345 | 0.2023 | | 0.2397 | 0.2023 | | 0.2449 | 0.2023 | | 0.2501 | 0.2023 | | 0.2553 | 0.2023 | | 0.2605 | 0.2023 |
| | 0.2397 | 0.2023 | | 0.2449 | 0.2023 | | 0.2501 | 0.2023 | | 0.2553 | 0.2023 | | 0.2605 | 0.2023 | | 0.2657 | 0.2023 |
| | 0.2354 | 0.1944 | | 0.2406 | 0.1944 | | 0.2458 | 0.1944 | | 0.2510 | 0.1944 | | 0.2562 | 0.1944 | | 0.2614 | 0.1944 |
| H11S | 0.2345 | 0.2023 | J11S | 0.2397 | 0.2023 | K11S | 0.2449 | 0.2023 | M11S | 0.2501 | 0.2023 | N11S | 0.2553 | 0.2023 | P11S | 0.2605 | 0.2023 |
| | 0.2388 | 0.2102 | | 0.2440 | 0.2102 | | 0.2492 | 0.2102 | | 0.2544 | 0.2102 | | 0.2596 | 0.2102 | | 0.2648 | 0.2102 |
| | 0.2440 | 0.2102 | | 0.2492 | 0.2102 | | 0.2544 | 0.2102 | | 0.2596 | 0.2102 | | 0.2648 | 0.2102 | | 0.2700 | 0.2102 |
| | 0.2397 | 0.2023 | | 0.2449 | 0.2023 | | 0.2501 | 0.2023 | | 0.2553 | 0.2023 | | 0.2605 | 0.2023 | | 0.2657 | 0.2023 |
| H12X | 0.2388 | 0.2102 | J12X | 0.2440 | 0.2102 | K12X | 0.2492 | 0.2102 | M12X | 0.2544 | 0.2102 | N12X | 0.2596 | 0.2102 | P12X | 0.2648 | 0.2102 |
| | 0.2431 | 0.2181 | | 0.2483 | 0.2181 | | 0.2535 | 0.2181 | | 0.2587 | 0.2181 | | 0.2639 | 0.2181 | | 0.2691 | 0.2181 |
| | 0.2483 | 0.2181 | | 0.2535 | 0.2181 | | 0.2587 | 0.2181 | | 0.2639 | 0.2181 | | 0.2691 | 0.2181 | | 0.2743 | 0.2181 |



| | | | | | | | | | | | | | | | | | | | |
|------|--------|--------|------|--------|--------|------|--------|--------|------|--------|--------|------|--------|--------|------|--------|--------|--------|--------|
| | 0.2440 | 0.2102 | | 0.2492 | 0.2102 | | 0.2544 | 0.2102 | | 0.2596 | 0.2102 | | 0.2648 | 0.2102 | | 0.2700 | 0.2102 | | |
| H12S | 0.2431 | 0.2181 | J12S | 0.2483 | 0.2181 | K12S | 0.2535 | 0.2181 | M12S | 0.2587 | 0.2181 | N12S | 0.2639 | 0.2181 | P12S | 0.2691 | 0.2181 | | |
| | 0.2474 | 0.2260 | | 0.2526 | 0.2260 | | 0.2578 | 0.2260 | | 0.2630 | 0.2260 | | 0.2682 | 0.2260 | | 0.2734 | 0.2260 | 0.2786 | 0.2260 |
| | 0.2526 | 0.2260 | | 0.2578 | 0.2260 | | 0.2630 | 0.2260 | | 0.2682 | 0.2260 | | 0.2734 | 0.2260 | | 0.2786 | 0.2260 | | |
| | 0.2483 | 0.2181 | | 0.2535 | 0.2181 | | 0.2587 | 0.2181 | | 0.2639 | 0.2181 | | 0.2691 | 0.2181 | | 0.2743 | 0.2181 | | |
| H13X | 0.2474 | 0.2260 | J13X | 0.2526 | 0.2260 | K13X | 0.2578 | 0.2260 | M13X | 0.2630 | 0.2260 | N13X | 0.2682 | 0.2260 | P13X | 0.2734 | 0.2260 | | |
| | 0.2517 | 0.2339 | | 0.2569 | 0.2339 | | 0.2621 | 0.2339 | | 0.2673 | 0.2339 | | 0.2725 | 0.2339 | | 0.2777 | 0.2339 | 0.2829 | 0.2339 |
| | 0.2569 | 0.2339 | | 0.2621 | 0.2339 | | 0.2673 | 0.2339 | | 0.2725 | 0.2339 | | 0.2777 | 0.2339 | | 0.2829 | 0.2339 | | |
| | 0.2526 | 0.2260 | | 0.2578 | 0.2260 | | 0.2630 | 0.2260 | | 0.2682 | 0.2260 | | 0.2734 | 0.2260 | | 0.2786 | 0.2260 | | |
| H13S | 0.2517 | 0.2339 | J13S | 0.2569 | 0.2339 | K13S | 0.2621 | 0.2339 | M13S | 0.2673 | 0.2339 | N13S | 0.2725 | 0.2339 | P13S | 0.2777 | 0.2339 | | |
| | 0.2560 | 0.2418 | | 0.2612 | 0.2418 | | 0.2664 | 0.2418 | | 0.2716 | 0.2418 | | 0.2768 | 0.2418 | | 0.2820 | 0.2418 | | |
| | 0.2612 | 0.2418 | | 0.2664 | 0.2418 | | 0.2716 | 0.2418 | | 0.2768 | 0.2418 | | 0.2820 | 0.2418 | | 0.2872 | 0.2418 | | |
| | 0.2569 | 0.2339 | | 0.2621 | 0.2339 | | 0.2673 | 0.2339 | | | | | | | | | | | |

| | | | | | | | | | | | | | | | | | |
|------|--------|--------|------|--------|--------|------|--------|--------|------|--------|--------|------|--------|--------|------|--------|--------|
| | 0.2956 | 0.3050 | | 0.3008 | 0.3050 | | 0.3060 | 0.3050 | | 0.3112 | 0.3050 | | 0.3164 | 0.3050 | | 0.3216 | 0.3050 |
| | 0.2913 | 0.2971 | | 0.2965 | 0.2971 | | 0.3017 | 0.2971 | | 0.3069 | 0.2971 | | 0.3121 | 0.2971 | | 0.3173 | 0.2971 |
| H18X | 0.2904 | 0.3050 | J18X | 0.2956 | 0.3050 | K18X | 0.3008 | 0.3050 | M18X | 0.3060 | 0.3050 | N18X | 0.3112 | 0.3050 | P18X | 0.3164 | 0.3050 |
| | 0.2947 | 0.3129 | | 0.2999 | 0.3129 | | 0.3051 | 0.3129 | | 0.3103 | 0.3129 | | 0.3155 | 0.3129 | | 0.3207 | 0.3129 |
| | 0.2999 | 0.3129 | | 0.3051 | 0.3129 | | 0.3103 | 0.3129 | | 0.3155 | 0.3129 | | 0.3207 | 0.3129 | | 0.3259 | 0.3129 |
| | 0.2956 | 0.3050 | | 0.3008 | 0.3050 | | 0.3060 | 0.3050 | | 0.3112 | 0.3050 | | 0.3164 | 0.3050 | | 0.3216 | 0.3050 |
| H18S | 0.2947 | 0.3129 | J18S | 0.2999 | 0.3129 | K18S | 0.3051 | 0.3129 | M18S | 0.3103 | 0.3129 | N18S | 0.3155 | 0.3129 | P18S | 0.3207 | 0.3129 |
| | 0.2990 | 0.3208 | | 0.3042 | 0.3208 | | 0.3094 | 0.3208 | | 0.3146 | 0.3208 | | 0.3198 | 0.3208 | | 0.3250 | 0.3208 |
| | 0.3042 | 0.3208 | | 0.3094 | 0.3208 | | 0.3146 | 0.3208 | | 0.3198 | 0.3208 | | 0.3250 | 0.3208 | | 0.3302 | 0.3208 |
| | 0.2999 | 0.3129 | | 0.3051 | 0.3129 | | 0.3103 | 0.3129 | | 0.3155 | 0.3129 | | 0.3207 | 0.3129 | | 0.3259 | 0.3129 |
| H19X | 0.2990 | 0.3208 | J19X | 0.3042 | 0.3208 | K19X | 0.3094 | 0.3208 | M19X | 0.3146 | 0.3208 | N19X | 0.3198 | 0.3208 | P19X | 0.3250 | 0.3208 |
| | 0.3033 | 0.3287 | | 0.3085 | 0.3287 | | 0.3137 | 0.3287 | | 0.3189 | 0.3287 | | 0.3241 | 0.3287 | | 0.3293 | 0.3287 |
| | 0.3085 | 0.3287 | | 0.3137 | 0.3287 | | 0.3189 | 0.3287 | | 0.3241 | 0.3287 | | 0.3293 | 0.3287 | | 0.3345 | 0.3287 |
| | 0.3042 | 0.3208 | | 0.3094 | 0.3208 | | 0.3146 | 0.3208 | | 0.3198 | 0.3208 | | 0.3250 | 0.3208 | | 0.3302 | 0.3208 |
| H19S | 0.3033 | 0.3287 | J19S | 0.3085 | 0.3287 | K19S | 0.3137 | 0.3287 | M19S | 0.3189 | 0.3287 | N19S | 0.3241 | 0.3287 | P19S | 0.3293 | 0.3287 |
| | 0.3076 | 0.3366 | | 0.3128 | 0.3366 | | 0.3180 | 0.3366 | | 0.3232 | 0.3366 | | 0.3284 | 0.3366 | | 0.3336 | 0.3366 |
| | 0.3128 | 0.3366 | | 0.3180 | 0.3366 | | 0.3232 | 0.3366 | | 0.3284 | 0.3366 | | 0.3336 | 0.3366 | | 0.3388 | 0.3366 |
| | 0.3085 | 0.3287 | | 0.3137 | 0.3287 | | 0.3189 | 0.3287 | | 0.3241 | 0.3287 | | 0.3293 | 0.3287 | | 0.3345 | 0.3287 |

Notes

1 Measurement uncertainty of the color coordinates: 0.003.

0.003.

2 The new white dustbin refers to the application of small backlight standard.

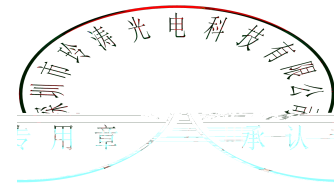

1.7 Typical Optical Characteristics Curves

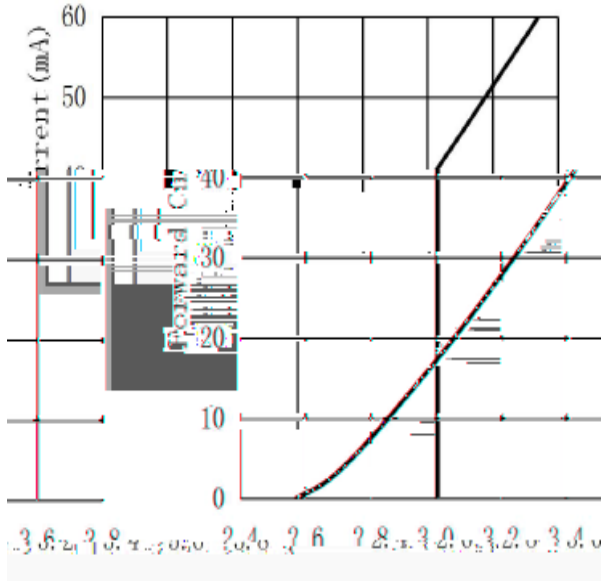

Fig. 1-7 Forward Voltage Vs Forward Current

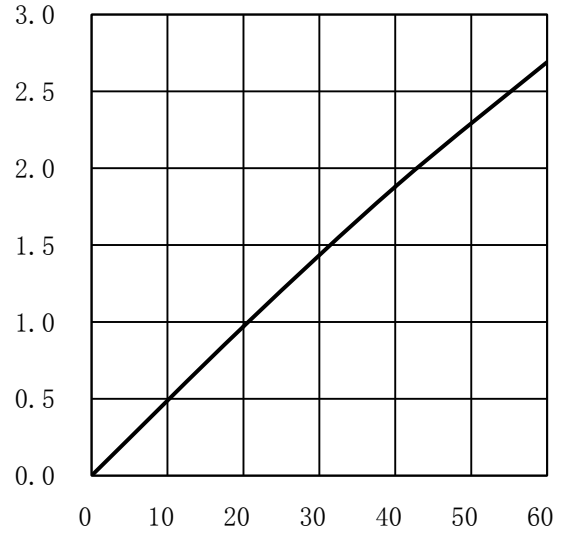

Fig. 1-8 Forward Current Vs Relative Intensity

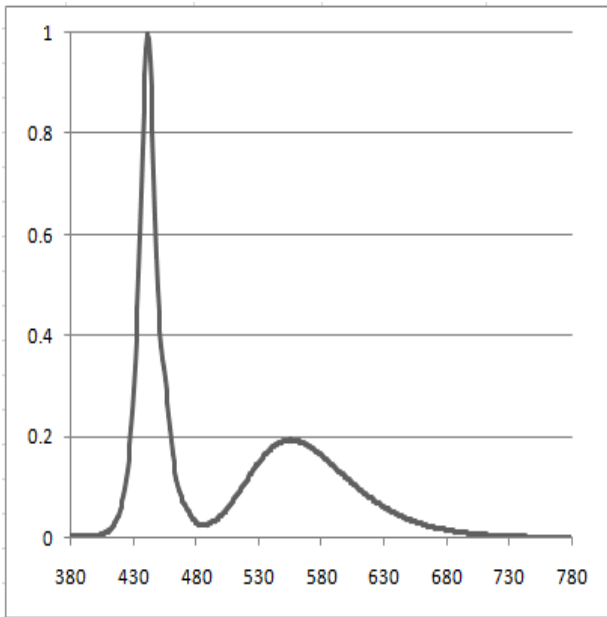

Fig. 1-9 Spectrum Distribution

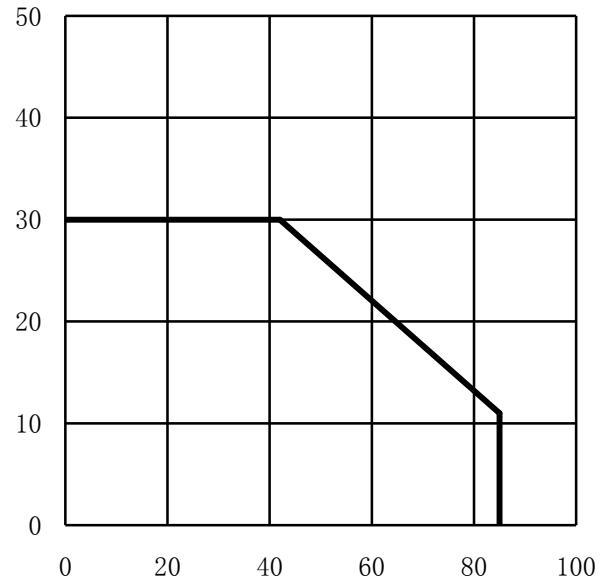
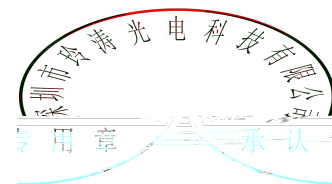

Fig 1-10 Solder Temperature Vs Forward Current

Tj 105



2. Packaging

2.1 Packaging Specification

A.Package:5000pcs/reel.

5000pcs

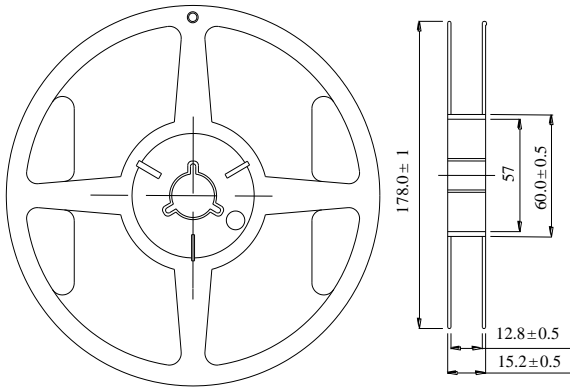

B.Package:10000pcs/reel.

10000pcs

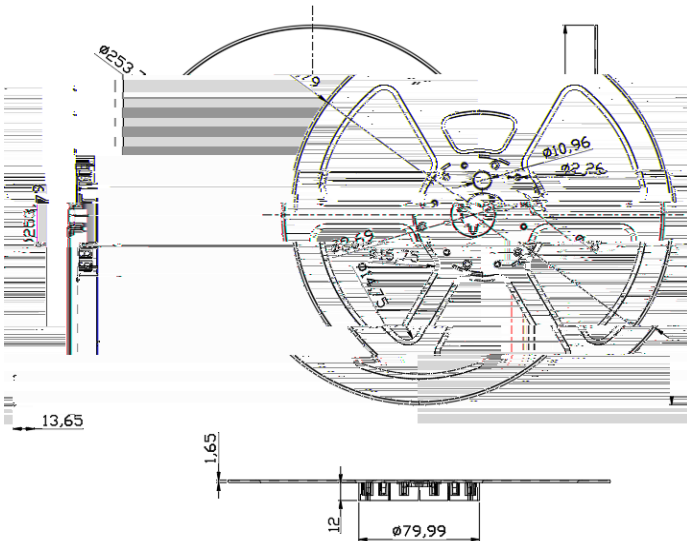

Notes

When the quantity is less than 10000pcs/roll, the quantity is 5000pcs per roll.

5000pcs

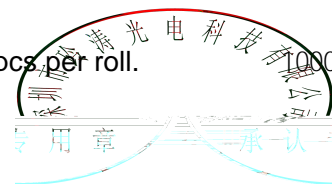

2.1.1 Carrier Tape Dimension

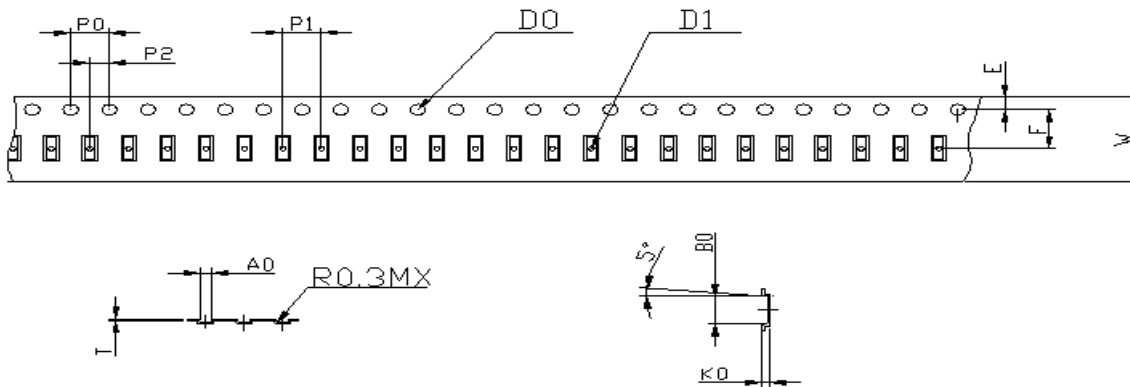

| | | | | | | | | | |
|----|------------|----|-----------|----|------------|----|-----------|----|-----------|
| P0 | 4.00 ±0.10 | P2 | 2±0.05 | P1 | 4.00±0.10 | D0 | 1.60±0.10 | D1 | 0.60±0.10 |
| E | 1.75±0.10 | F | 5.50±0.10 | W | 12.00±0.20 | A0 | 0.95±0.10 | T | 0.20±0.10 |
| B0 | 3.15±0.10 | K0 | 0.55±0.10 | | | | | | |

Fig.2-1 Carrier Tape Dimension

Notes

The tolerances unless mentioned ±0.2mm. Unit : mm

0.2

2.1.2 Label Form Specification

Table 2-2 Label Map



Table 2-3 Label Form Specification

| | |
|----------------|--------------------|
| PART NO. | Part Number |
| BIN CODE | Bin Code |
| IV | Luminous intensity |
| V _F | Forward Voltage |
| WL | Wavelength |
| QTY | Packing Quantity |
| DATE | Made Date |
| LOT NO | Lot Number |

2.2 Moisture Resistant Packing

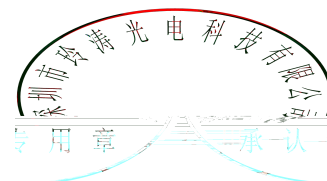

Fig.2-4 Moisture Resistant Packing

2.3 Cardboard Box

Fig.2-5 Cardboard Box

2.4 Reliability Test Items And Conditions

Table 2-6 Reliability Test Items And Conditions

| TestItems | Test Condition | Time | Quantity |
|-----------|----------------|------|----------|
|-----------|----------------|------|----------|

| | | | | |
|---------------------------------------|-----------------------|----------|--------|-----|
| Life Test | Ta=25 If=20mA | 1000hrs. | 20pcs. | 0/1 |
| High Temperature and Humidity storage | 60 / 90%RH | 1000hrs. | 20pcs. | 0/1 |
| Temperature Humidity Operation Life | 60 / 90%RH If=15mA | 500hrs | 20pcs. | 0/1 |

2.5 Criteria For Judging Damage

Table 2-7 Criteria For Judging Damage

| Test Items | Symbol | Test Condition | Criteria For Judgement | |
|-----------------|----------------|----------------------|------------------------|--------------|
| | | | Min. | Max. |
| Forward Voltage | V _F | I _F =20mA | - | >U.S.L*)x1.1 |
| Reverse Current | I _R | V _R = 5V | - | >U.S.L*)x2.0 |
| Luminous Flux | | I _F =20mA | <L.S.L*)x0.7 | - |

Notes

- 1.U.S.L: Upper standard level L.S.L: Lower standard level
- 2.The above reliability tests is based on the verification of a single/strip LED of LT existing experimental platform,the reliability experiment was taken under good heat dissipation conditions. when customers applies the LED to the series and parallel circuit, should take consideration of all the factors such as the current, voltage distribution, heat dissipation and others.

LED

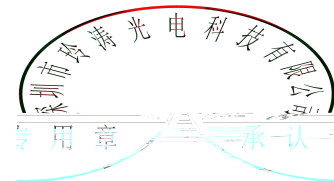

3.The technical information shown in the data sheets is limited to the typical characteristics and circuit examples of the referenced products. It does not constitute the warranting of industrial property nor the granting of any license.

3. SMT Reflow Soldering Instructions SMT 回流焊说明

3.1 SMT Reflow Soldering Instructions

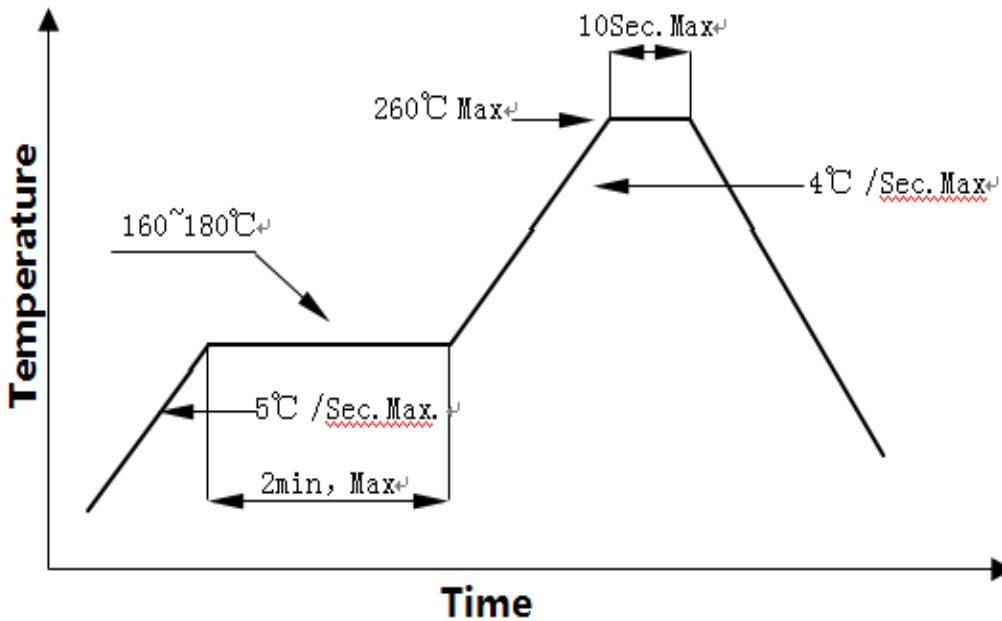

Fig.3-1 SMT Reflow Soldering Map

Fig.3-2 SMT Reflow Soldering Instructions SMT

| | | | | |
|--|----------------------|-------------------|----------|-------------|
| Average temperature rise speed | T _{smax} | T _P | 5 °C/ | Max 5 °C/ s |
| Preheating: minimum temperature | (T _{smin}) | | 160 °C | |
| Preheating: Max temperature | (T _{smax}) | | 260 °C | |
| Preheating: Time | T _{smin} | T _{smax} | 60 - 120 | 60s-120s |
| Time limited to maintain high temperature: the temperature | (T _L) | | 217 °C | |
| Time limited to maintain high temperature: The Time | (t _L) | | 60 | Max 60s |
| Peak /Classification of temperature: | / | (T _P) | | 260 °C |

| | | | |
|--|--|-------|---------------|
| Time limit classification of peak temperature time | t_p | 10 | Max 10s |
| (T_p) 5 °C | Hold time within 5 °C with the actual peak temperature (T_p) | 30 | Max 30s |
| Cooling speed | | 6 °C/ | Max 6 °C/ s |
| 25 °C | Needed time from 25 °C to T_p | 8 | Max 8 minutes |

Notes

(1)Reflow soldering should not be done more than twice. If more than 24 hours between the two solderings , LED will be damaged. 24 LED

(2)Whensoldering , do not put stress on the LEDs during heating.

3.1.1 Soldering Iron

(1) When do soldering by hand, keep the temperature of iron below less 300°C less than 3 seconds. 300 3

(2) Soldering by hand should be done only one time.

3.1.2 Repairing

Repairing should not be done after the LEDs have been soldered. When repairing is unavoidable,a double-head soldering iron should be used (as below figure). It should be confirmed in advance whether the characteristics of LEDs will or not be damaged by repairing.

LED

LED

3.1.3 Cautions

(1) The encapsulated material of the LEDs is silicone. Therefore the LEDs have a soft surface on the top of package. The pressure to the top surface will be impacted on the reliability of the LEDs.

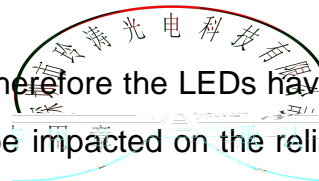

Precautions should be taken to avoid the strong pressure on the encapsulated part. So when use the picking up nozzle, the pressure on the silicone resin should be proper. LED

LED

(2) Components should not be mounted on warped (non coplanar) portion of PCB. After soldering, do not warp the circuit board. LED PCB

(3) Do not apply mechanical force or excess vibration during the cooling process to normal temperature after soldering. Do not rapidly cool device after soldering.

4. Handling Precautions

4.1 Handling Precautions

(1) LED operating environment and sulfur element composition cannot be over 100PPM in the LED mating usage material. This is provided for informational purposes only and is not a warranty or endorsement. LED LED 100PPM.

(2) In order to prevent external material from getting into the inside of LED, which may cause the malfunction of LED, the single content of Bromine element is required to be less than 900PPM, the single content of Chlorine element is required to be less than 900PPM, the total content of Bromine element and Chlorine element in the external materials of the application products is required to be less than 1500PPM. This is provided for informational purposes only and is not a warranty or endorsement. LED LED

900PPM

900PPM

1500PPM.

(3) VOCs (Volatile organic compounds) emitted from materials used in the construction of fixtures can penetrate silicone encapsulants of LEDs and discolor when exposed to heat and photonic energy. The result can be a significant loss of light output from the fixture. Knowledge of the properties of the materials selected to be used in the construction of fixtures can help prevent these issues. LT advises against the use of any chemicals or materials that have been found or are suspected to have an adverse affect on device performance or reliability. To

verify compatibility, LT recommends that all chemicals and materials be tested in the specific application and environment for which they are intended to be used. Attaching LEDs, do not use adhesives that outgas organic vapor.

LED

LED

LED

LED

(4) Handle the component along the side surface by using forceps or appropriate tools; do not directly touch or Handle the silicone lens surface, it may damage the internal circuitry.

(5) In designing a circuit, the current through each LED must exceed the absolute maximum rating specified for each LED. In the meanwhile, resistors for protection should be applied, otherwise slight voltage shift will cause big current change, burn out may happen. The driving circuit must be designed to allow forward voltage only when it is ON or OFF. If the reverse voltage is applied to LED, migration can be generated resulting in LED damage.

LED

LED

(6) Thermal Design is paramount importance because heat generation may result in the Characteristics decline, such as brightness decreased, Color change and so on. Please consider the heat generation of the LEDs when making the system design. LED

LED

(7) Compared to standard encapsulants, silicone is generally softer, and the surface is more likely to attract dust, requiring special care during processing. In cases where a minimal level of dirt and dust particles cannot be guaranteed, a suitable cleaning solution must be applied to the surface after the soldering of components. LT suggests using isopropyl alcohol for cleaning. In case other solvents are used, it must be assured that these solvents do not dissolve the package or resin. Ultrasonic cleaning is not recommended. Ultrasonic cleaning may cause damage to the LED.



LED

Table 4-1 Storage

| Conditions | | Temperature | Humidity | Time |
|------------|-----------------------------|-------------|----------|-------------------------|
| Storage | Before Opening Aluminum Bag | 30 | 75% | Within 1 Year From Date |
| | After Opening Aluminum Bag | 30 | 60% | 24hours 24 |
| Baking | | 60 ± 5 | - | 24hours 24 |

(8) If the moisture absorbent material (silica gel) has faded away or the LEDs have exceeded the storage time , baking treatment should be performed after unpacking and based on the following condition (65±5) °C for above 24 hours.

60 ± 5 24

If the package is flatulence or damaged, please notify the sales staff to assist.

(9) Similar to most Solid state devices; LEDs are sensitive to Electro-Static Discharge (ESD) and Electrical Over Stress (EOS).

LED

