

# SPECIFICATION

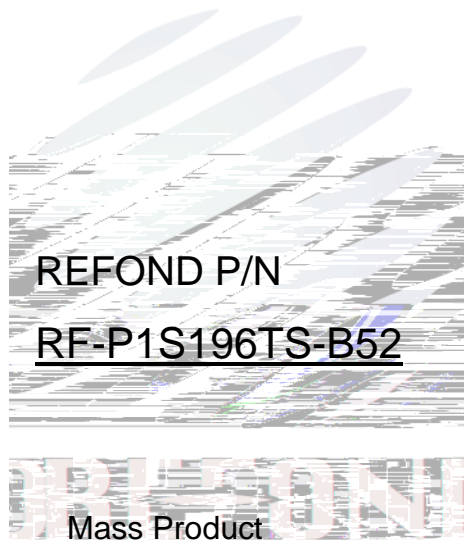

## Contents

1. Description	3
1.1 General Description	3
1.2 Features	3
1.3 Application	3
1.4 Package Dimension	4
1.5 Product Parameters	5
1.6 Typical Optical Characteristics Curves	7
2. Packaging	11
2.1 Packaging Specification	11
2.1.1 Carrier Tape Dimension	11
2.1.2 Reel Dimension	11
2.1.3 Label Form Specification	12
2.2 Moisture Resistant Packing	12
2.3 Cardboard Box	13
2.4 Reliability Test Items And Conditions	13
2.5 Criteria For Judging Damage	14
3. SMT Reflow Soldering Instructions SMT 回流焊说明	15
3.1 SMT Reflow Soldering Instructions SMT	15
4. Handling Precautions	17
4.1 Handling Precautions	17



# 1. Description

## 1.1 General Description



The Colour LED which was fabricated using a yellow chip and red chip , Package Dimension : 1.6mmX1.6mmX0.7mm.

以

以

1.6mmX1.6mmX0.7mm

## 1.2 Features

Extremely wide viewing angle.

Suitable for all SMT assembly and solder process.

Moisture sensitivity level: Level 3.

RoHS compliant.

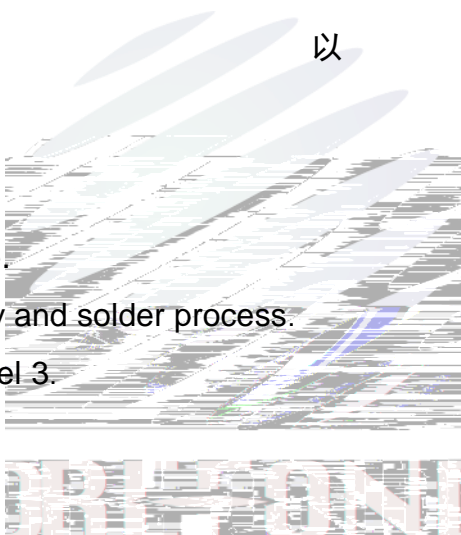

## 1.3 Application

Optical indicator.

Switch and symbol, display.

General use.

严以



### 1.4 Package Dimension

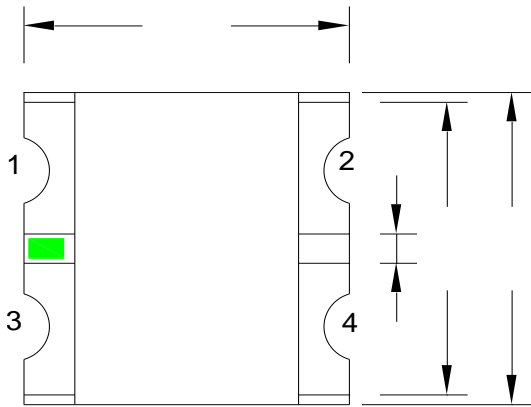

Fig.1-1 Top view

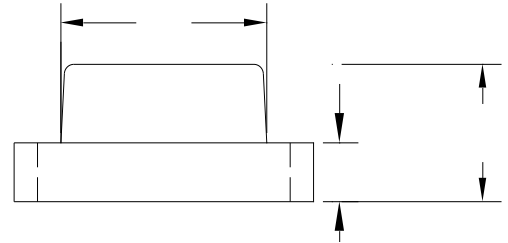

Fig.1-2 Side view

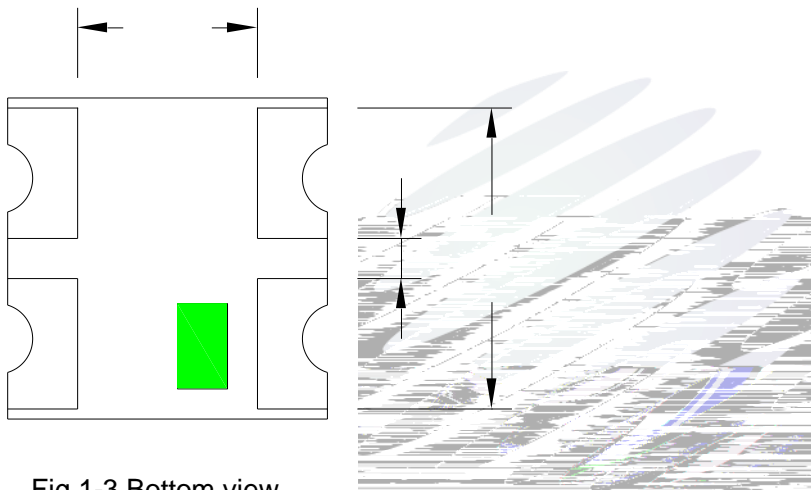

Fig.1-3 Bottom view

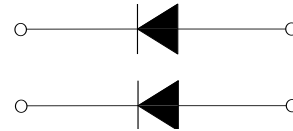

Fig.1-4 Polarity

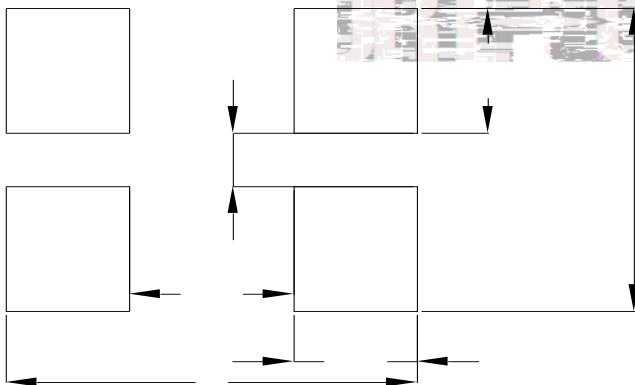

Fig.1-5 Soldering patterns

Notes

All dimensions units are millimeters.

2. All dimensions tolerances are  $\pm 0.2\text{mm}$  unless otherwise noted.



## 1.5 Product Parameters

Table 1-1 Electrical / Optical Characteristics at Ts=25°C

Item	Test Condition	Symbol		Code	Value			Unit
					Min. ( )	Typ.	Max.	
Spectral Half Bandwidth	I <sub>F</sub> =20mA	Δ	R	/	--	15	--	nm
			Y		--	15	--	
Forward Voltage	I <sub>F</sub> =20mA	V <sub>F</sub>	R	1L	1.8	--	2.4	V
			Y	1L	1.8	--	2.4	
Dominant wavelength	I <sub>F</sub> =20mA	λ <sub>d</sub>	R	F00	625.0	--	630.0	nm
				G00	630.0	--	635.0	
				H00	635.0	--	640.0	
				D00	585.0	--	590.0	

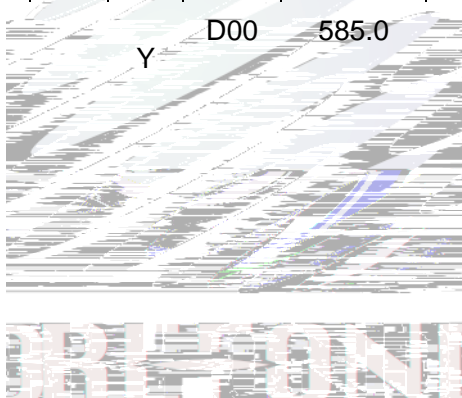

Table 1-2 Absolute Maximum Ratings at Ts=25°C

Parameter	Symbol	Rating		Units
		R	Y	
Power Dissipation	$P_d$	72	72	mW
Forward Current	$I_F$	30		mA
Peak Forward Current Of Pulse	$I_{FP}$	60		mA
Electrostatic Discharge (HBM)	$E_{SD}$	2000		V
Operating Temperature	$T_{opr}$	-40 ~ +85		°C
Storage Temperature	$T_{stg}$	-40 ~ +85		°C
Junction Temperature	$T_j$	95		°C

## Notes

- 1/10 Duty cycle, 0.1ms pulse width.
- The above forward voltage measurement allowance tolerance is  $\pm 0.1V$ .
- The above dominant wavelength measurement allowance tolerance is  $\pm 2nm$ .
- The above luminous intensity measurement allowance tolerance  $\pm 10\%$ .
- Care is to be taken that power dissipation does not exceed the absolute maximum rating of the product.

以

- All measurements were made under the standardized environment of Refond.

- When the LEDs are in operation the maximum current should be decided after measuring the package temperature, junction temperature should not exceed the maximum rate

以以

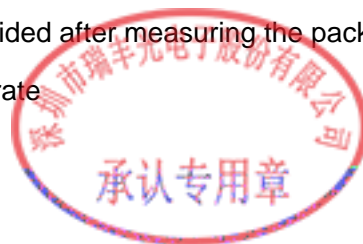

## 1.6 Typical Optical Characteristics Curves

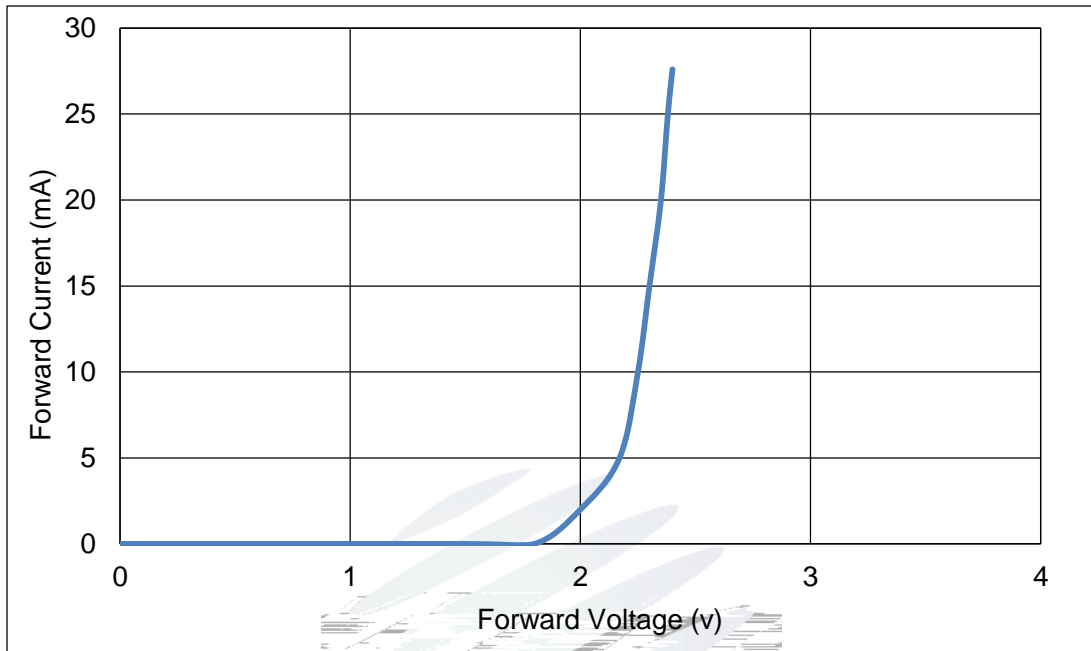

Fig.1-7 Forward Voltage Vs Forward Current

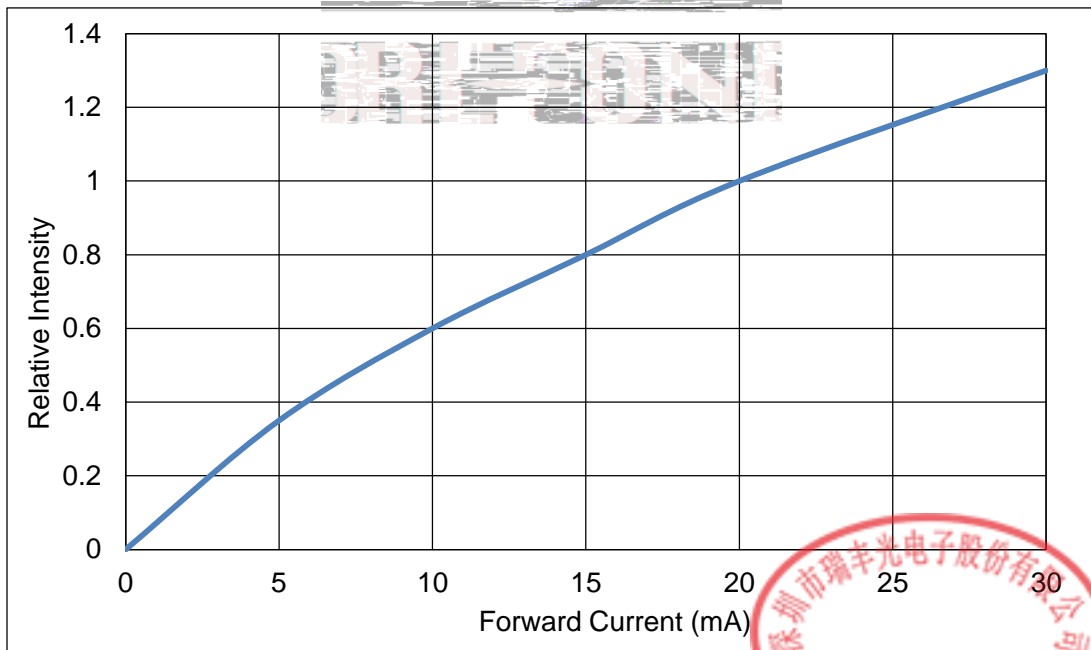
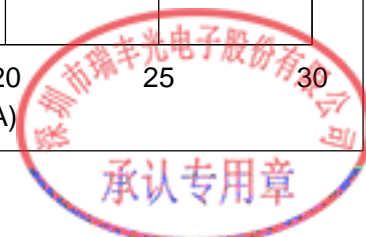

Fig.1-8 Forward Current Vs Relative Intensity



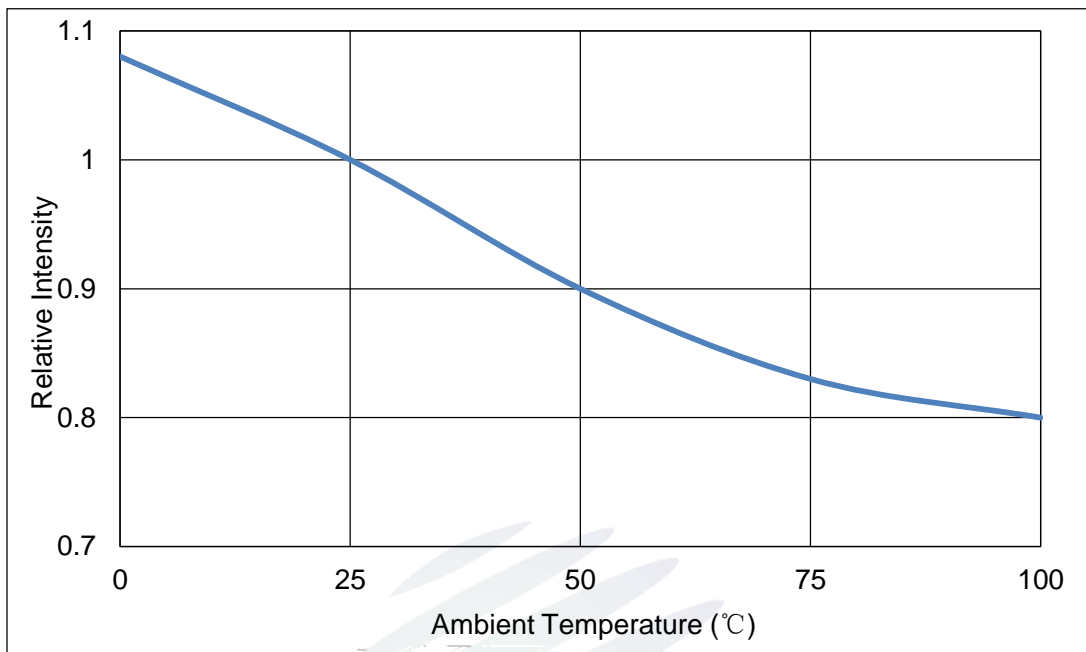

Fig.1-9 Pin Temperature Vs Relative Intensity ■

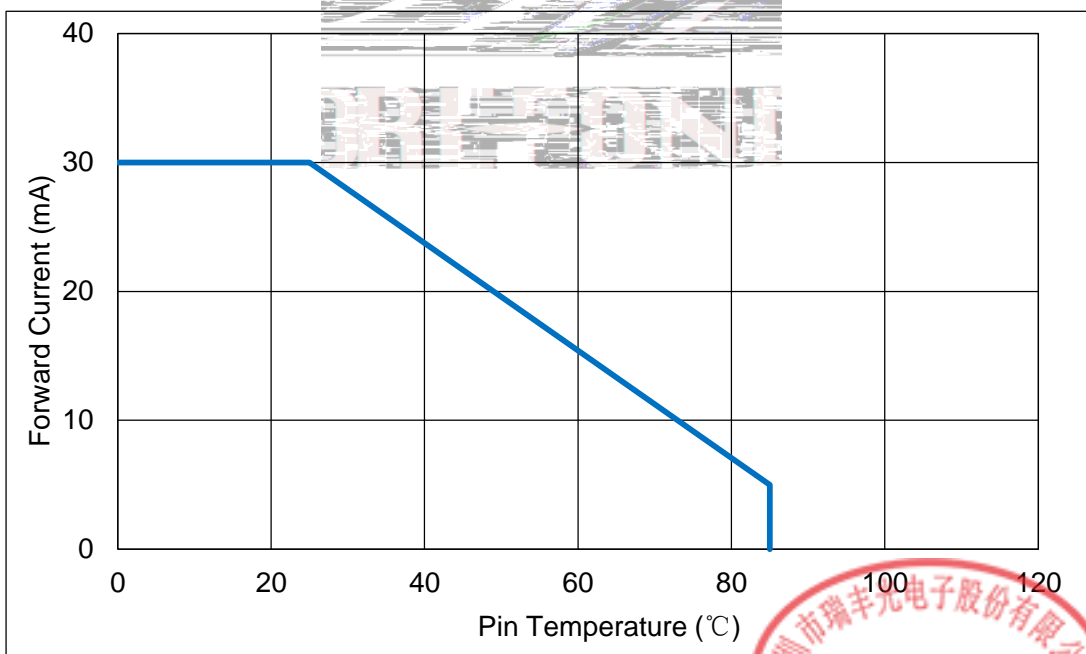
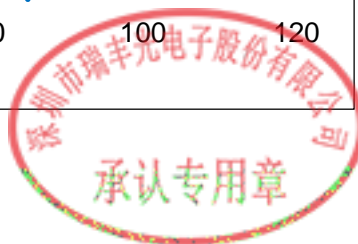

Fig.1-10 Pin Temperature Vs Forward Current ■



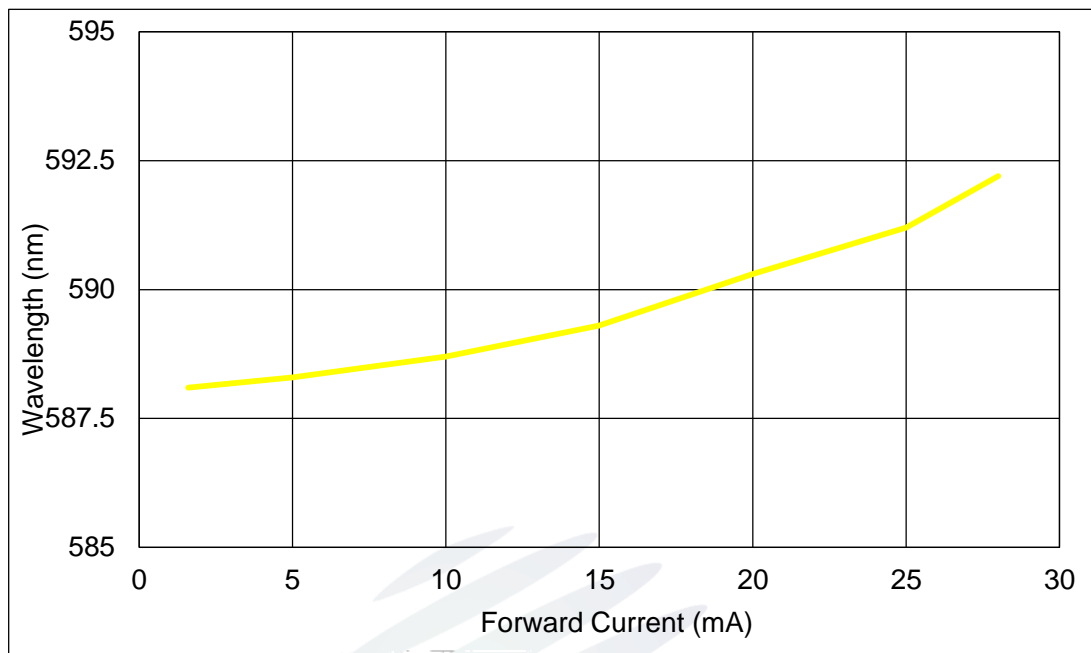

Fig.1-11 Forward Current Vs Dominate Wavelength (Ta=25 )

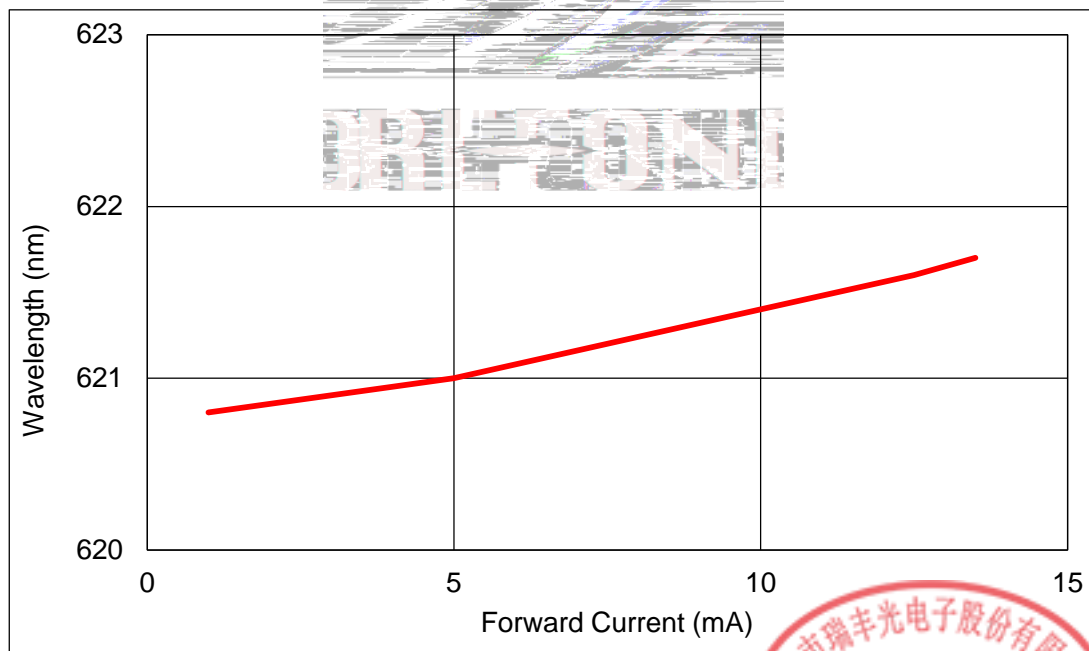

Fig.1-12 Forward Current Vs Dominate Wavelength (Ta=25°C)



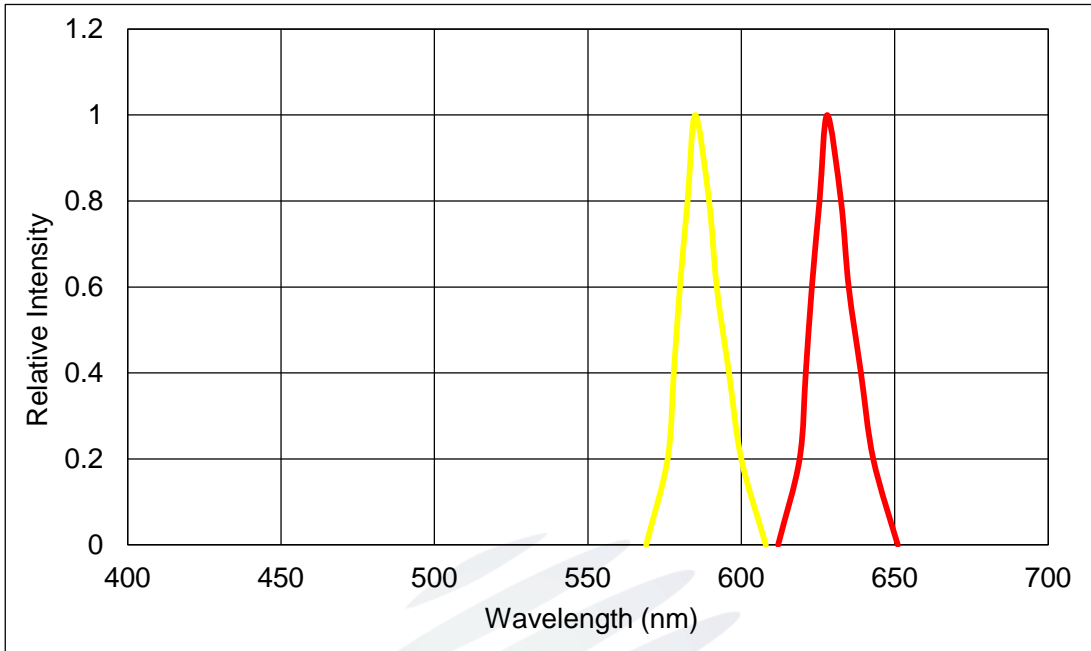

Fig.1-13 Relative Intensity Vs Wavelength (Ta=25 )

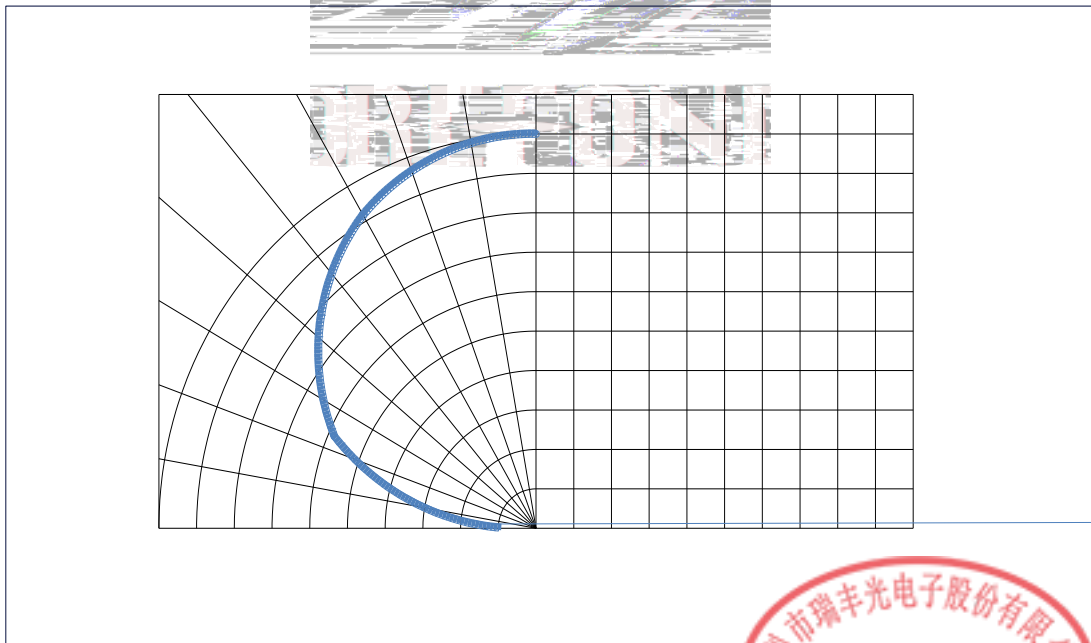

Fig.1-14 Diagram characteristics of radiation



## 2. Packaging

### 2.1 Packaging Specification

Package:4000pcs/reel. 4000pcs

#### 2.1.1 Carrier Tape Dimension



Fig.2-1 Carrier Tape Dimension

#### 2.1.2 Reel Dimension

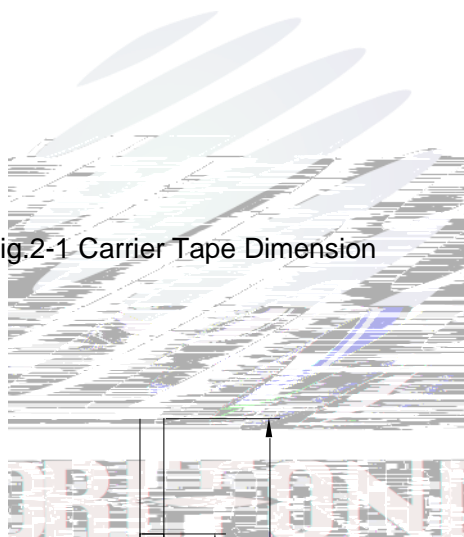
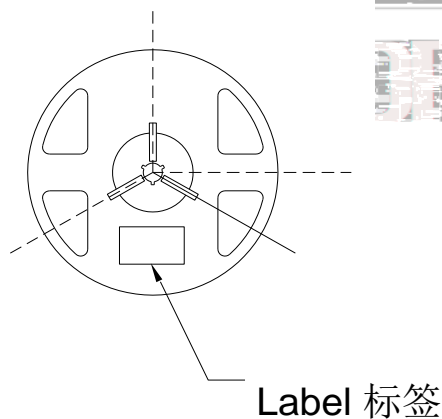

Table 2-1 Dimension

A	8.0 0.1mm
B	178 1mm
C	60 1mm
D	13.0 0.5mm

Fig.2-2 Reel Dimension

#### Notes

The tolerances unless mentioned  $\pm 0.1\text{mm}$ . Unit : mm



### 2.1.3 Label Form Specification



PART NO:		
SPEC NO:		
LOT NO		
BIN CODE:		
Φ:	XY:	
VF:	WLD:	
	QTY:	
	DATE:	

Table 2-2 Parameter

PART NO.	Part Number
SPEC NO.	Spec Number
LOT NO.	Lot Number
BIN CODE	Bin Code
	Luminous flux
XY	Chromaticity Bin
V <sub>F</sub>	Forward Voltage
WLD	Wavelength
QTY	Packing Quantity
DATE	Made Date

Fig. 2-3 Label Form Specification

### 2.2 Moisture Resistant Packing



Fig.2-4 Moisture Resistant Packing



## 2.3 Cardboard Box

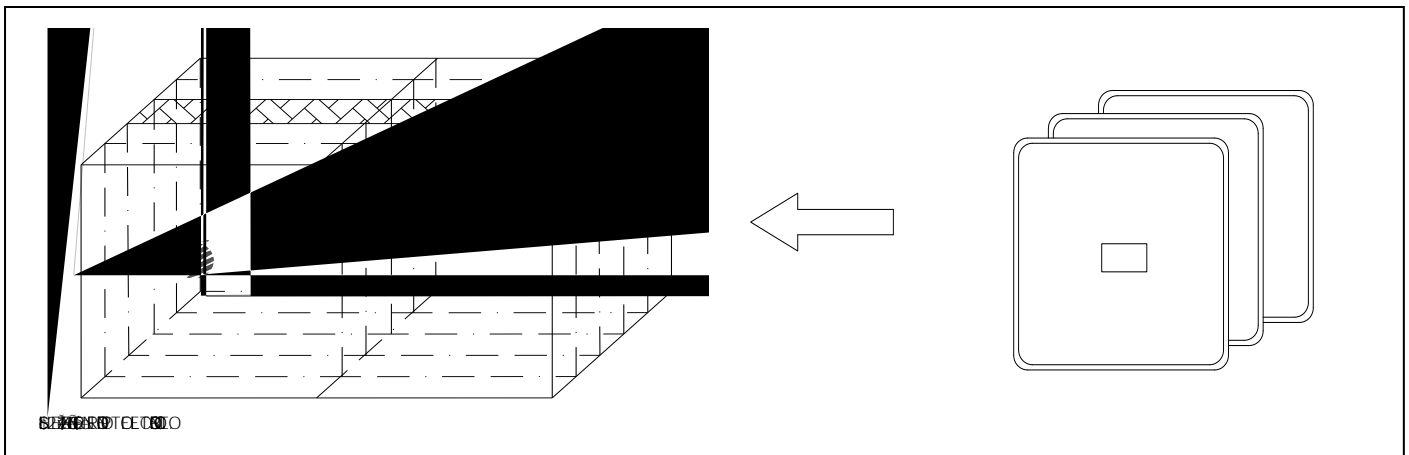
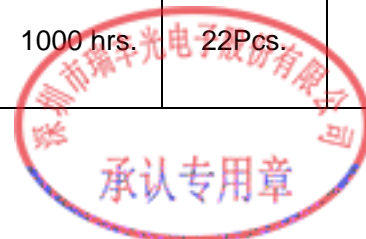

Fig.2-5 Cardboard Box

## 2.4 Reliability Test Items And Conditions

Table 2-3 Reliability Test Items And Conditions

Test Items	Ref.Standard	Test Condition	Time	Quantity	Ac/Re /
Reflow	JESD22-B106	Temp:260 max T=10 sec	2 times	22Pcs.	0/1
Temperature Cycle	JESD22-A104	100 30 min 5 min -40 30 min	100 cycles	22Pcs.	0/1
Thermal Shock	JESD22-A106	-40 15min 100 15min	300 cycles	22Pcs.	0/1
High Temperature Storage	JESD22-A103	Temp:100	1000 hrs.	22Pcs.	0/1
Low Temperature Storage	JESD22-A119	Temp:-40	1000 hrs.	22Pcs.	0/1
Life Test	JESD22-A108	T <sub>a</sub> =25 I <sub>F</sub> =20mA	1000 hrs.	22Pcs.	0/1



## 2.5 Criteria For Judging Damage 以

Table 2-4 Criteria For Judging Damage 以

Test Items	Symbol	Test Condition	Criteria For Judgement 以	
			Min.	Max.
Forward Voltage	$V_F$	$I_F=20mA$	-	U.S.L*)x1.1
Reverse Current	$I_R$	$V_R= 5V$	-	U.S.L*)x2.0
Luminous Flux		$I_F=20mA$	L.S.L*)x0.7	-

### Notes

1.U.S.L: Upper standard level

L.S.L: Lower standard level

2.The above reliability tests is based on the verification of a single/strip LED of Refond's existing experimental platform,the reliability experiment was taken under good heat dissipation conditions. When customers applies the LED to the series and parallel circuit,should take consideration of all the factors such as the current, voltage distribution, heat dissipation and others.

以

3.The technical information shown in the data sheets is limited to the typical characteristics and circuit examples of the referenced products. It does not constitute the warranting of industrial property nor the granting of any license. 使 以 以



### 3. SMT Reflow Soldering Instructions SMT 回流焊说明

#### 3.1 SMT Reflow Soldering Instructions SMT

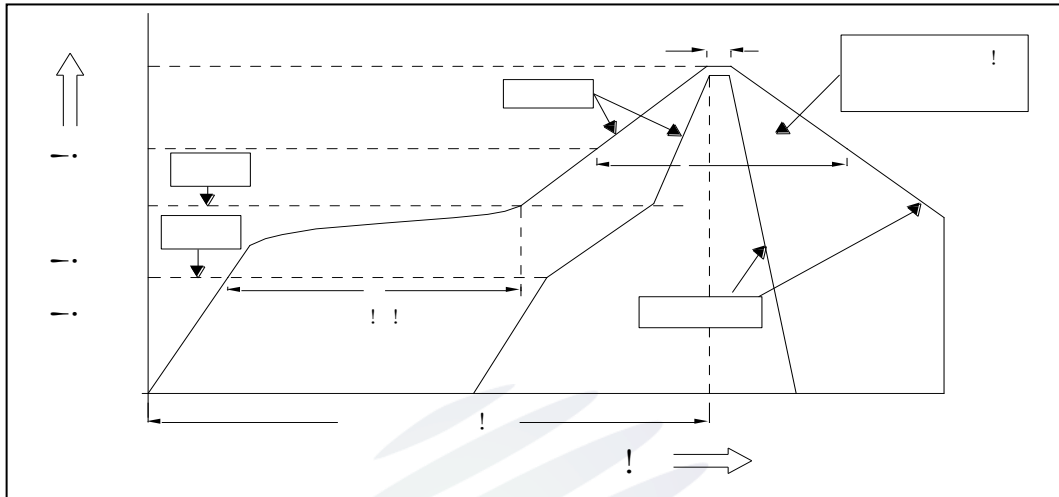

Fig.3-1 SMT Reflow Soldering Instructions SMT

Table 3-1 Parameter

Average temperature rise speed	$T_{smax}$ $T_P$	3 °C/ Max 3 °C/ s
Preheating: minimum temperature	( $T_{smin}$ )	150 °C
Preheating: Max temperature	( $T_{smax}$ )	200 °C
Preheating: Time	$T_{smin}$ $T_{smax}$	60 - 120 60s-120s
Time limited to maintain high temperature: the temperature	( $T_L$ )	217 °C
Time limited to maintain high temperature: The Time	( $t_L$ )	60 - 150 60s-150s
Peak /Classification of temperature:	/ ( $T_P$ )	260 °C
Time limit classification of peak temperature time	$t_p$	10 Max 10s
Hold time within 5 °C with the actual peak temperature ( $T_P$ )	( $T_P$ )	30 Max 30s
Cooling speed		6 °C/ Max 6 °C/ s
Needed time from 25 °C to $T_p$	25 °C	8 Max 8 minutes

Notes



(1)Reflow soldering should not be done more than twice. If more than 24 hours between the two solderings , LED will be damaged. 以 以

(2)Whensoldering , do not put stress on the LEDs during heating. 以

### 3.1.1 Soldering Iron

(1) When do soldering by hand, keep the temperature of iron below less 300°C less than 3 seconds. 以

(2) Soldering by hand should be done only one time.

### 3.1.2 Repairing

Repairing should not be done after the LEDs have been soldered. When repairing is unavoidable,a double-head soldering iron should be used (as below figure). It should be confirmed in advance whether the characteristics of LEDs will or not be damaged by repairing.

LED

以

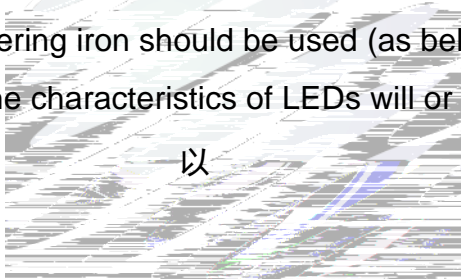

以

以

### 3.1.3 Cautions

(1) Components should not be mounted on warped (non coplanar) portion of PCB. After soldering, do not warp the circuit board.LED 以 以

(2) Do not apply mechanical force or excess vibration during the cooling process to normal temperature after soldering. Do not rapidly cool device after soldering. 以

以

以

以



## 4. Handling Precautions

### 4.1 Handling Precautions

(1) LED operating environment and sulfur element composition can not be over 100PPM in the LEDmating usage material. This is provided for informational purposes only and is not a warranty or endorsement.

以

(2) In order to prevent ex-ternal material from getting into the inside of LED, which may cause the malfunction of LED, the single content of Bromine element is required to be less than 900PPM,the single content of Chlorine elementis required to be less than 900PPM,the total content of Bromine element and Chlorine element in the external materials of the application products is required to be less than 1500PPM. This is provided for informational purposes only and is not a warranty or endorsement.

以

以

以

以

(3) VOCs (Volatile organic compounds) emitted from materials used in the construction of fixtures can penetrate silicone encapsulants of LEDs and discolor when exposed to heat and photonic energy. The result can be a significant loss of light output from the fixture. Knowledge of the properties of the materials selected to be used in the construction of fixtures can help prevent these issues. Refond advises against the use of any chemicals or materials that have been found or are suspected to have an adverse affect on device performance or reliability. To verify compatibility, Refond recommends that all chemicals and materials be tested in the specific application and environment for which they are intended to be used. Attaching LEDs, do not use adhesives that outgas organic vapor.

以

以

以

以

以

以

以

以





LED. 以 以 以 以 以  
 以 以 以 以 以  
 以 以 以 以 以

Table 4-1 Storage

Conditions		Temperature	Humidity	Time
Storage	Before Opening Aluminum Bag	30	75%	Within 1 Year From Date
	After Opening Aluminum Bag	30	60%	168hours 168
Baking		60 ± 5	-	24hours 24

(8) If the moisture absorbent material ( silica gel ) has faded away or the LEDs have exceeded the storage time, baking treatment should be performed after unpacking and based on the following condition ( 60±5 ) °C for above 24 hours. 以

以 以 以

If the package is flatulence or damaged, please notify the sales staff to assist. ■

以

(9) Similar to most Solid state devices; LEDs are sensitive to Electro-Static Discharge (ESD) and Electrical Over Stress (EOS). 以 以

(10) Other points for attention, please refer to our relevant information.



Date	Revisor	Version	Verifier	Remarks
2018.02.03		E/1		以
2021.07.07		E/2		
2022.06.20		E/3		

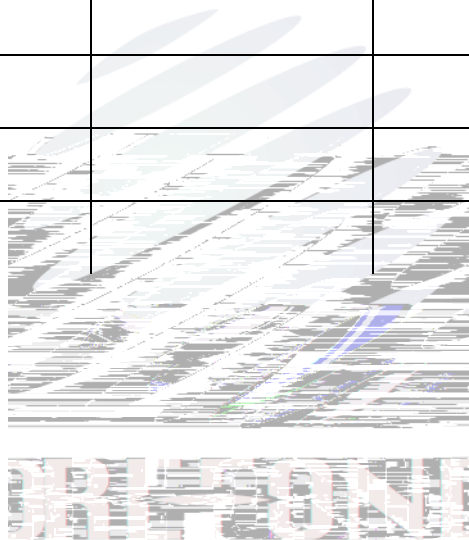



Declare

This specification is written both in English and in Chinese and the latter is formal.

以