

# SPECIFICATION

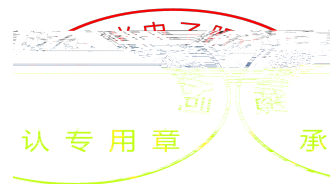

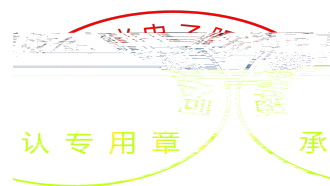

# 1. Description

## 1.1 General Description

## 1.2 Features

## 1.3 Application

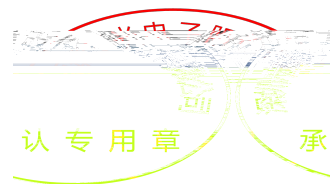
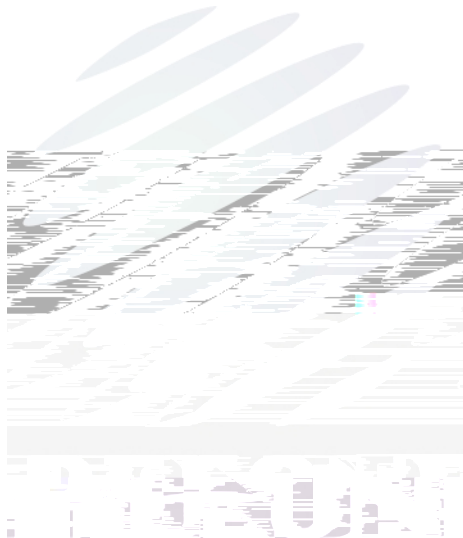

### 1.4 Package Dimension

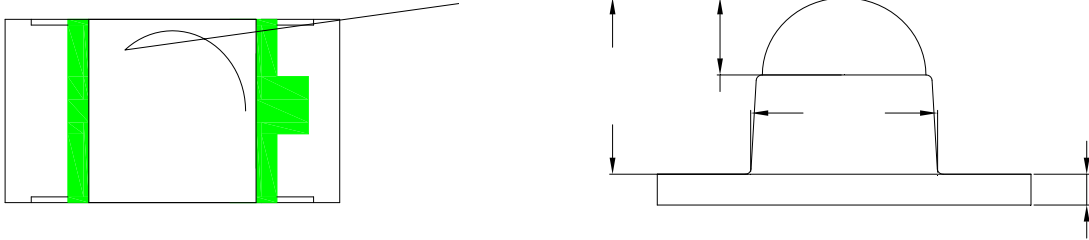

±

## 1.5 Product Parameters

	A					
F	A		B			
			C			
			D			
D	A		A			
			B			
			C			
	A					
	A					D
						$\mu A$
	A					

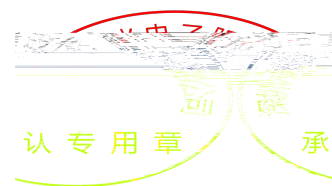

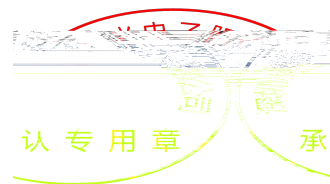
## 1.6 Typical optical characteristics curves

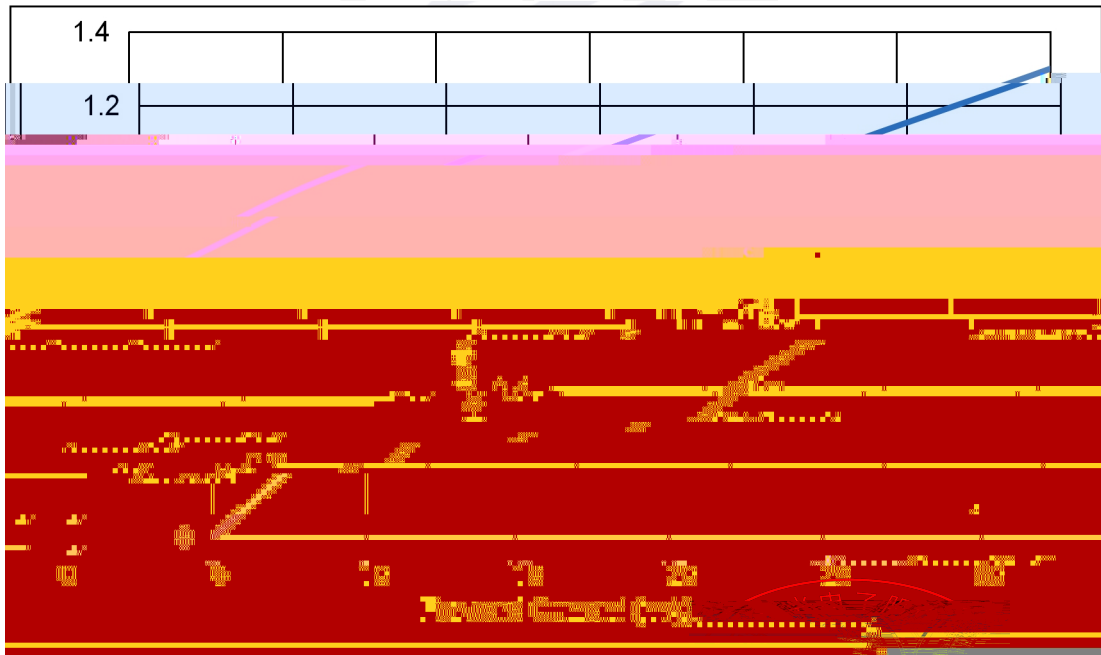
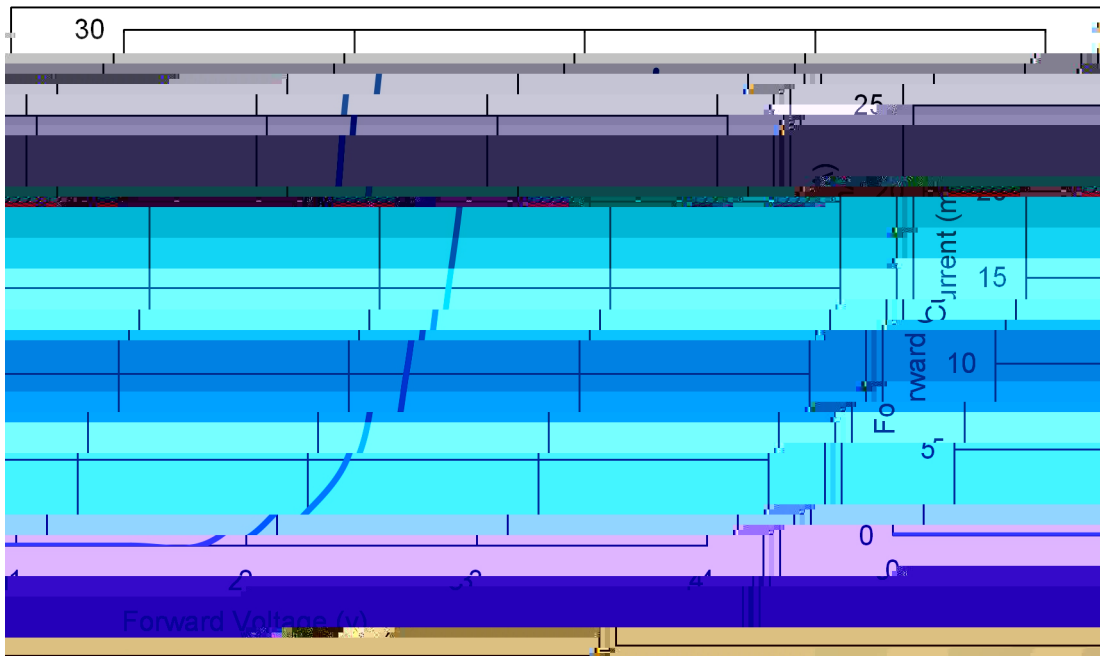

承 認 專 用 草 圖

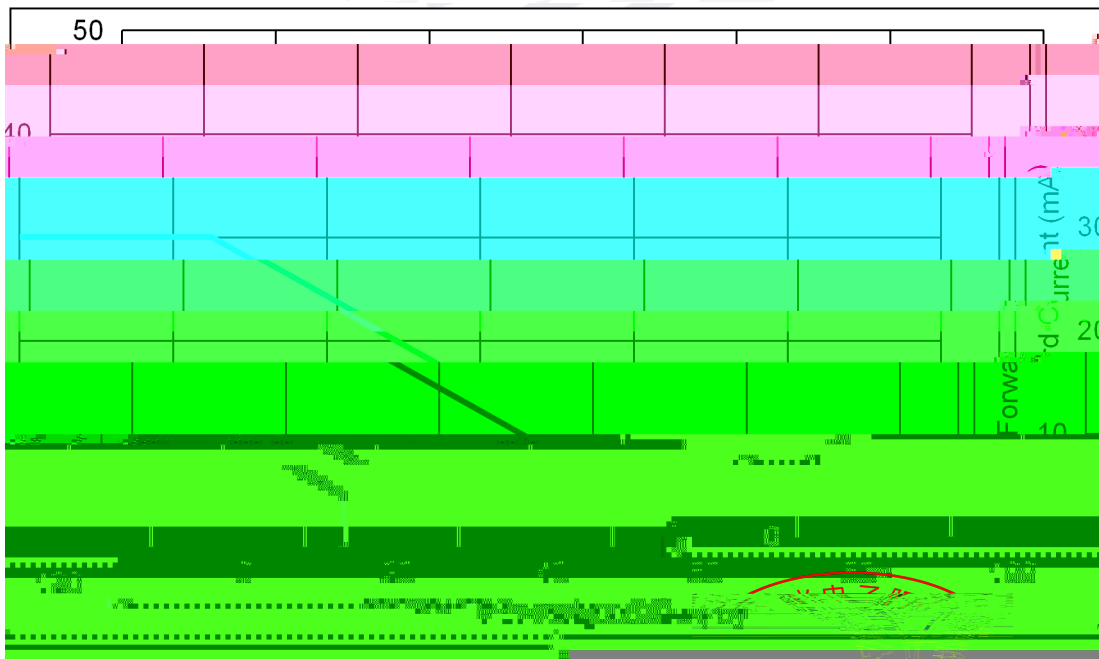
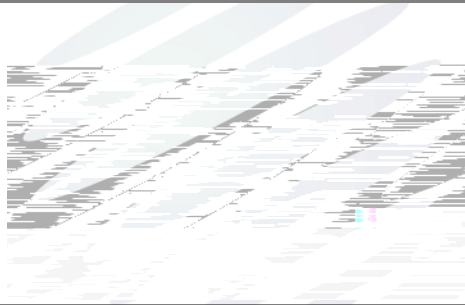
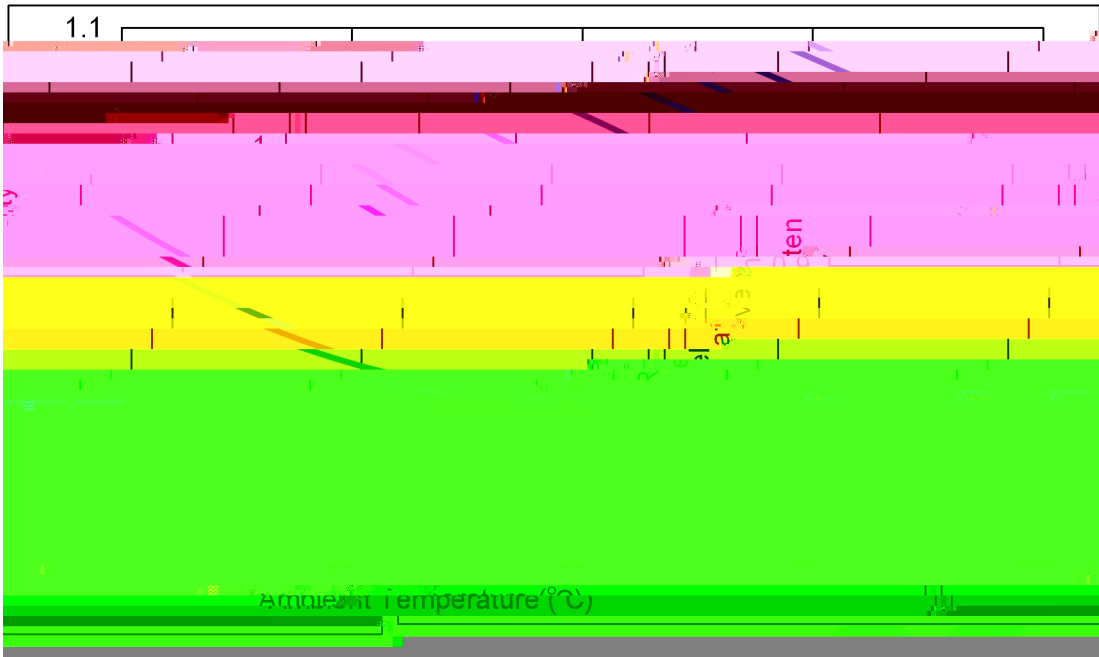

承 草 用 专 认

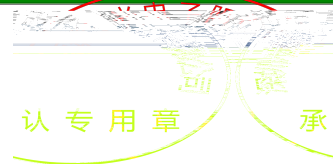
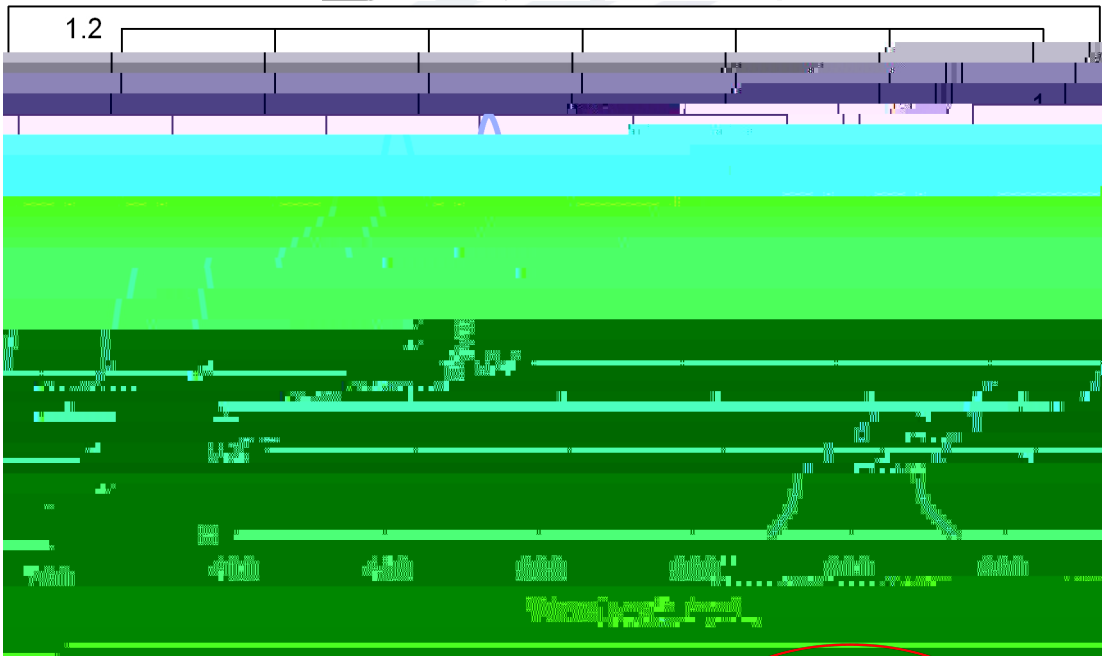
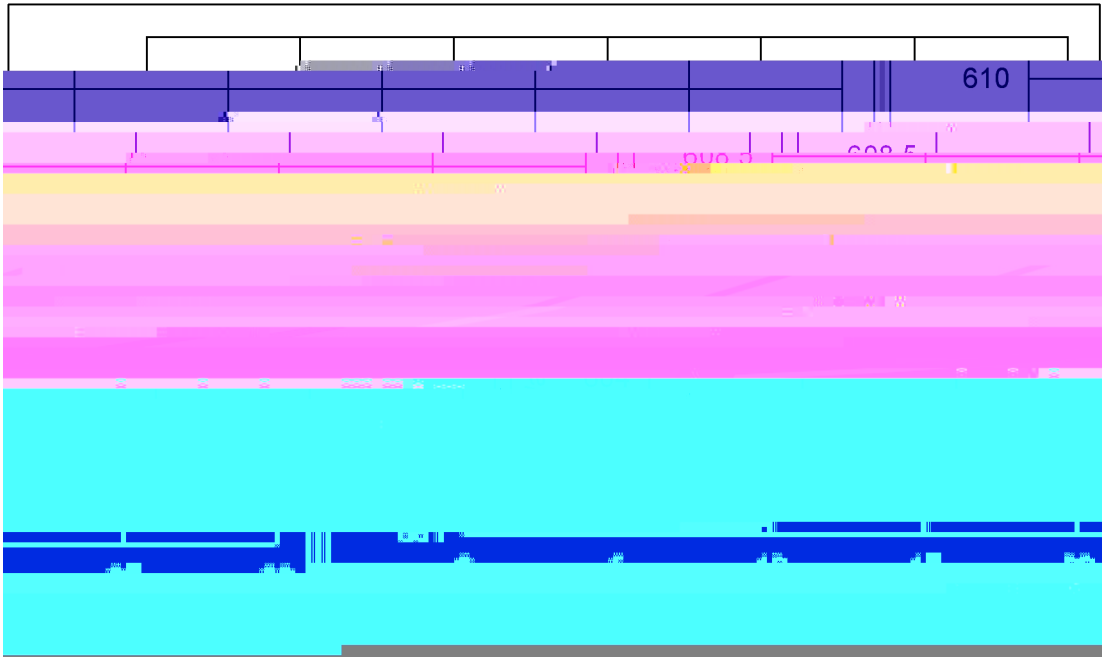

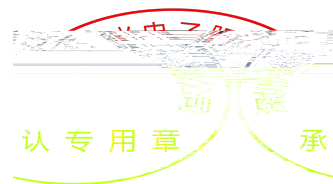
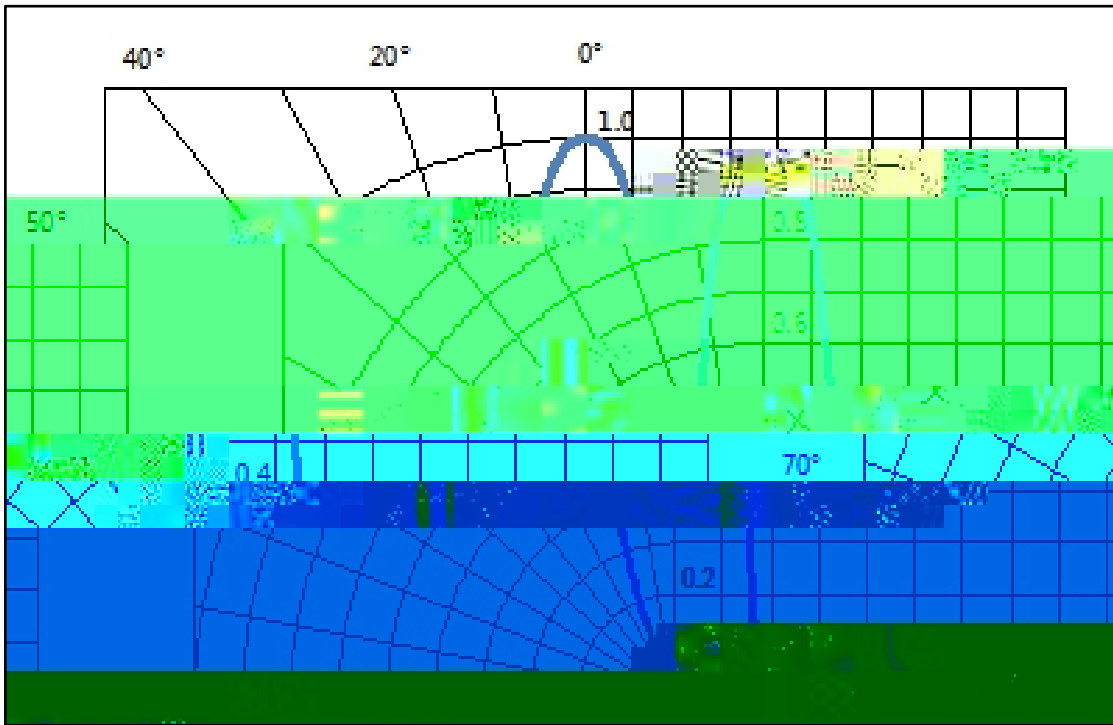

## 2. Packaging

### 2.1 Packaging Specification

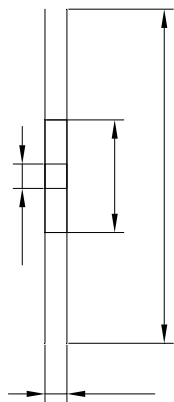
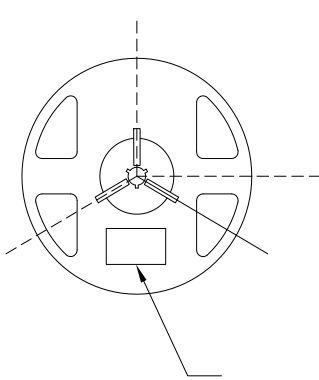
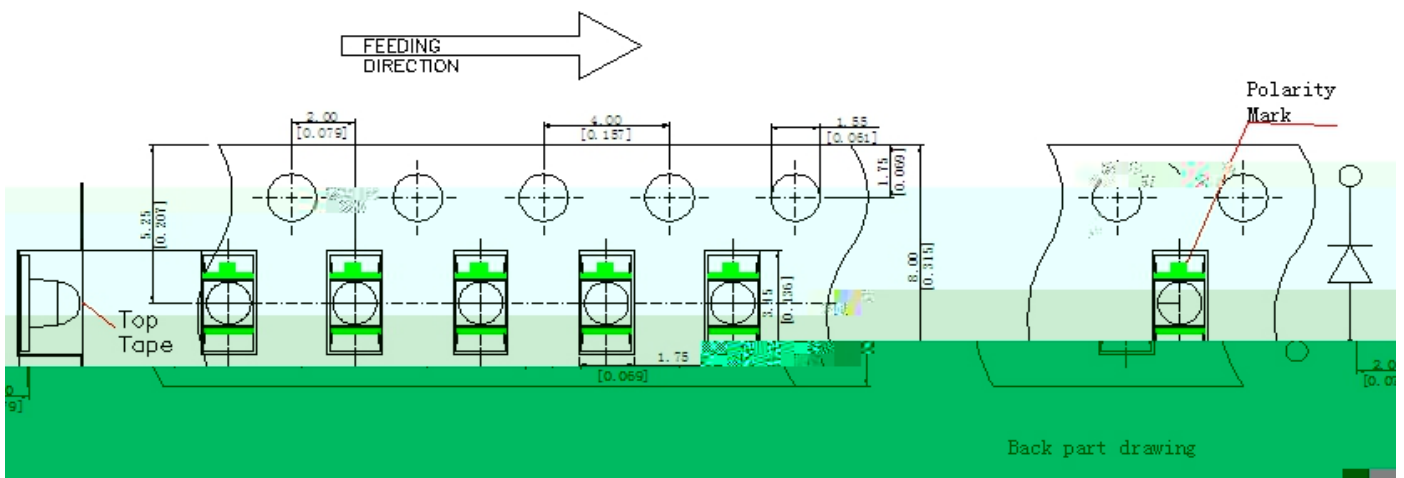

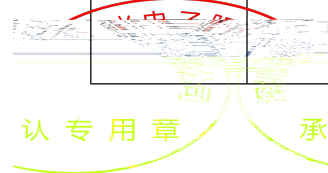
PART NO:	
PROD NO:	
LOT NO:	
BIN CODE:	
IV:	
VF:	
	WLD:
	Qty:
	Date:

---

---

---

---

---

---

---

---

---

---



## 2.2 Moisture Resistant Packing

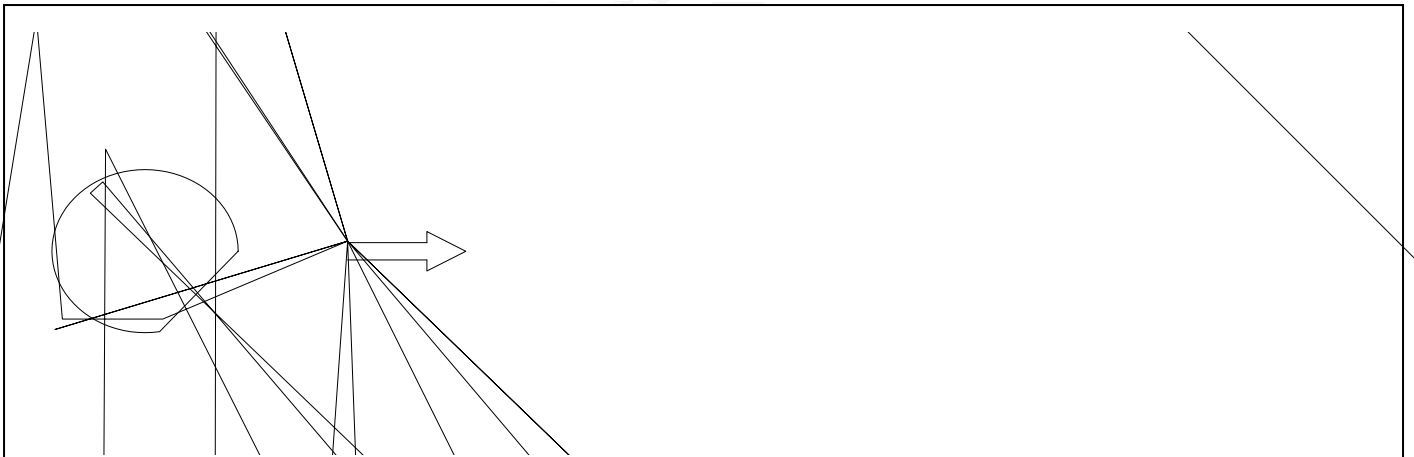

## 2.3 Cardboard Box

## 2.4 Reliability Test Items And Conditions

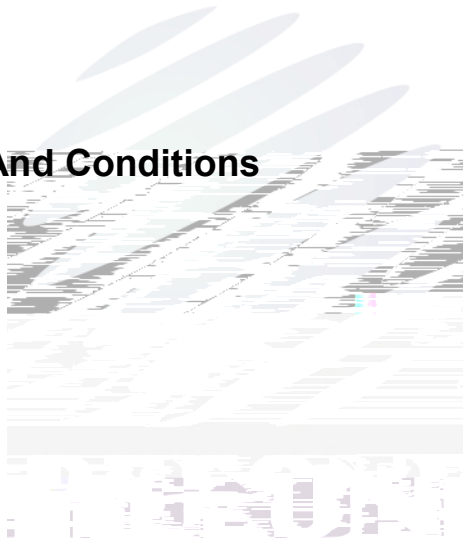

@ 3 0 1 2

## 2.5 Criteria For Judging Damage

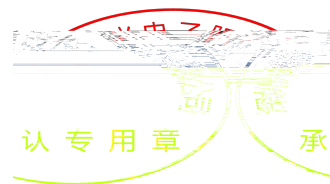

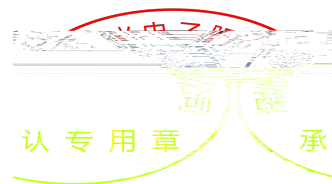

## 4. Handling Precautions

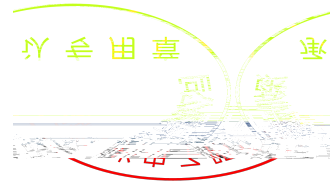

### 4.1 Handli

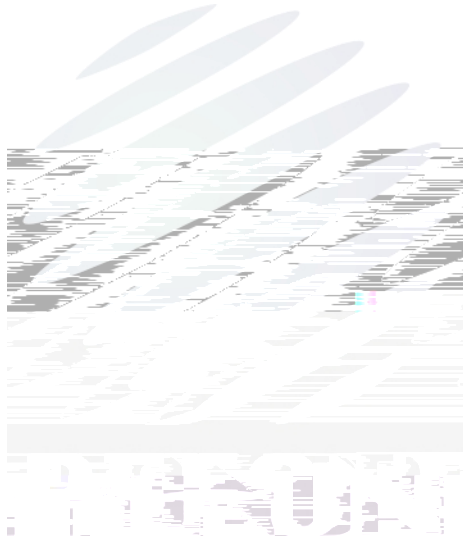

喜用云商

惠

世通云商

世通云商



