

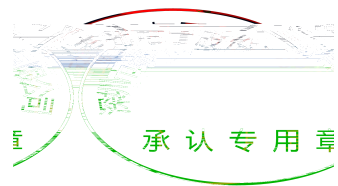

世通云商

REFORD

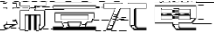

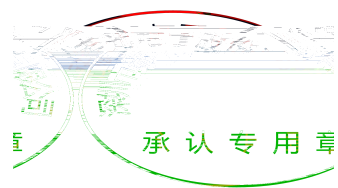

# 1.

## 1.1 General Description

## 1.2

## 1.3

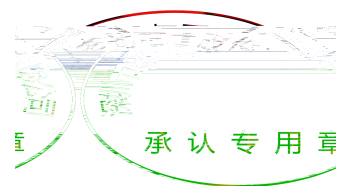

1.4

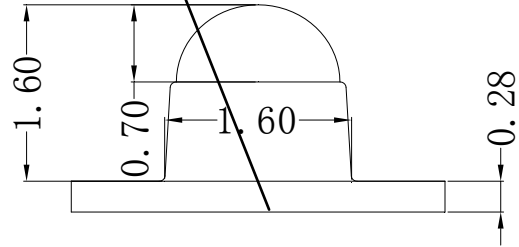
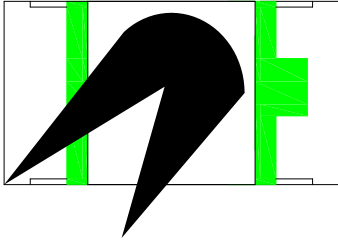

±

# 1.5

			△				
			A0	1.6	--	1.8	
			B0	1.8	--	2.0	
			C0	2.0	--	2.2	
			D0	2.2	--	2.4	
							μ
							

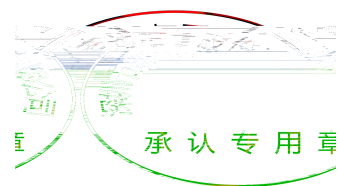

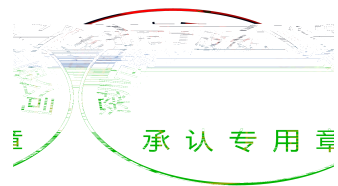
1.



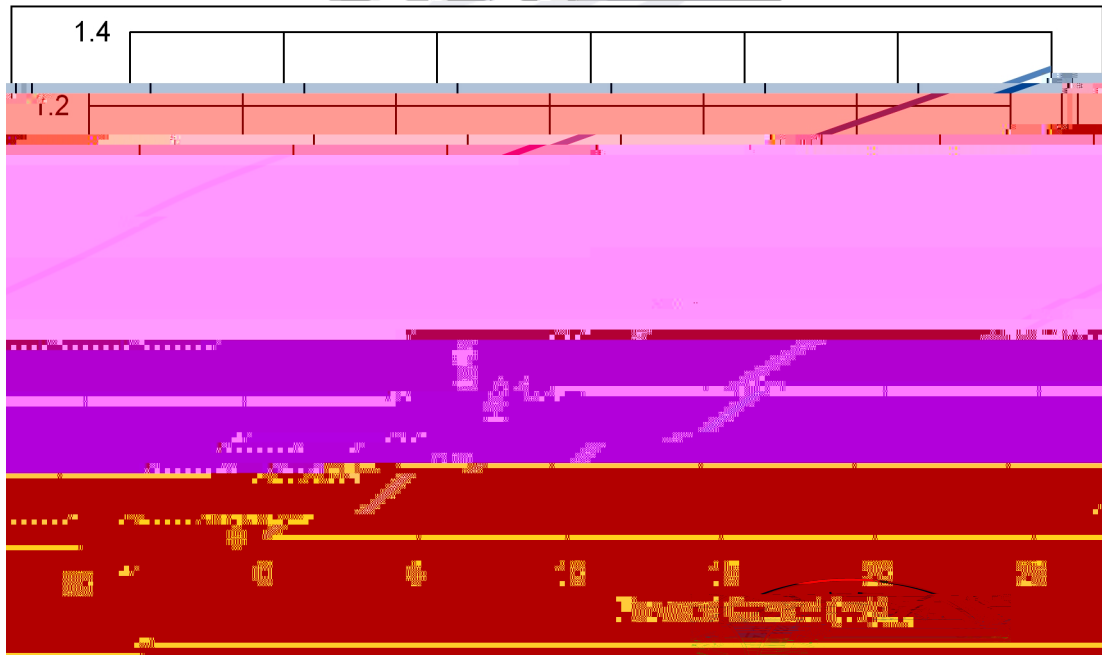
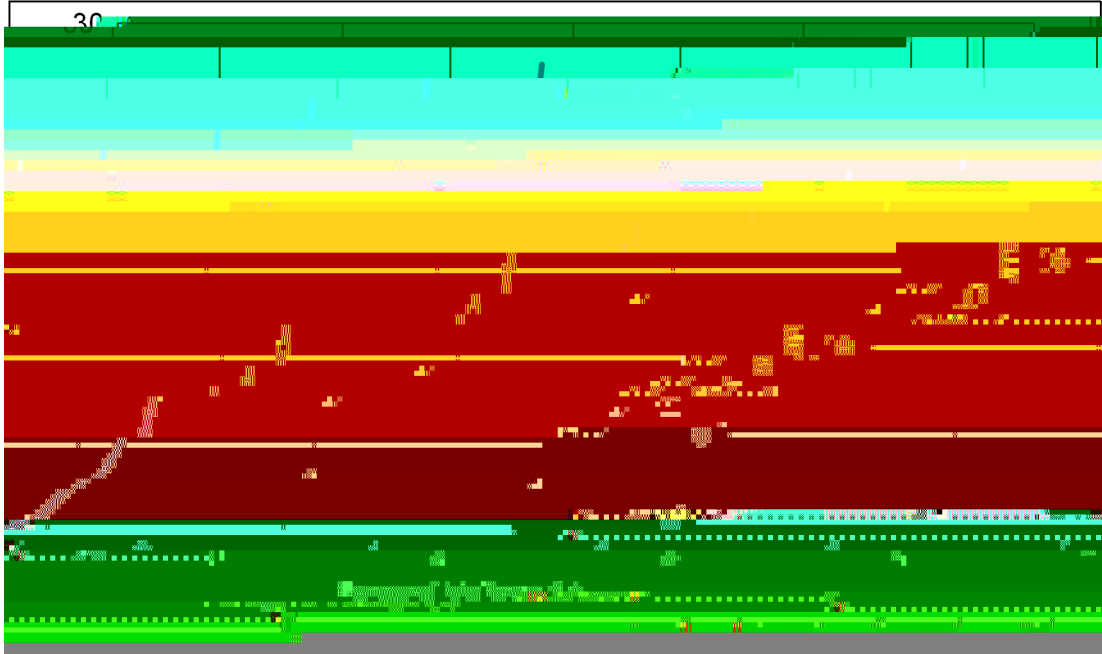

 变频调速器  
 承认专用章

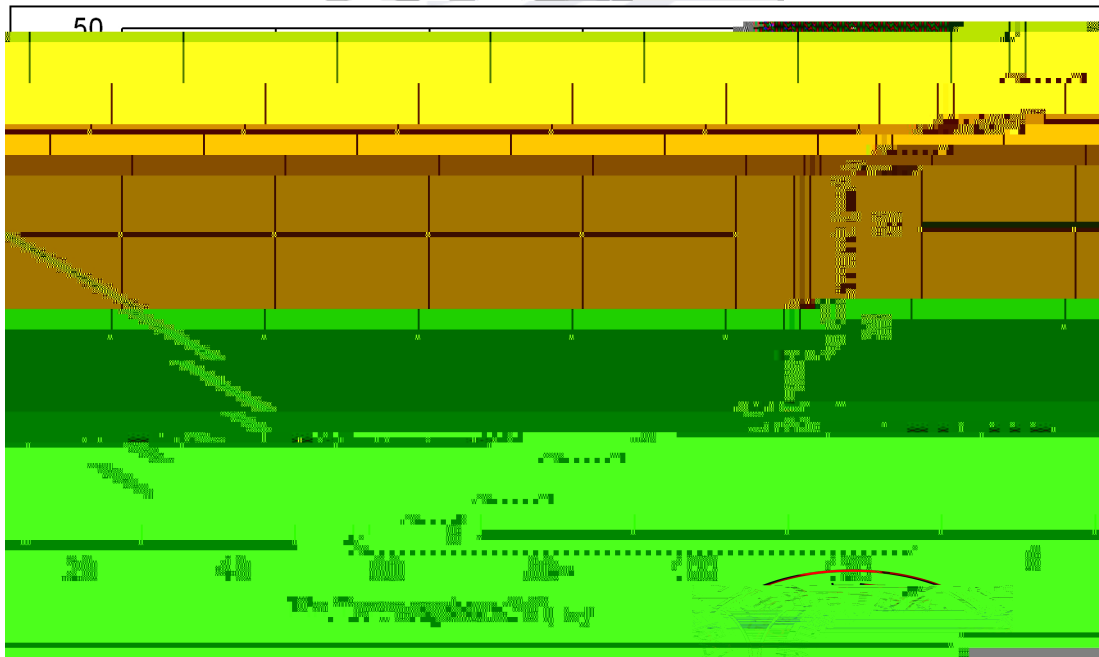
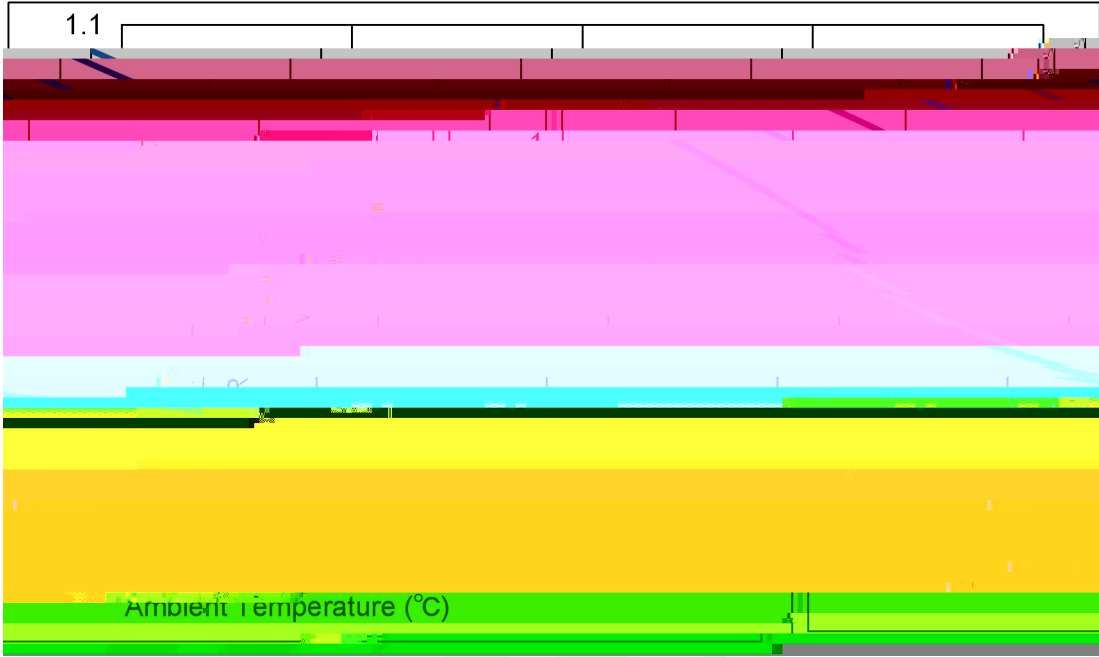

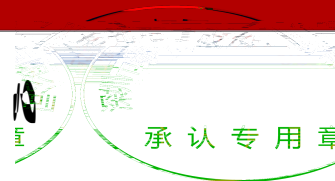
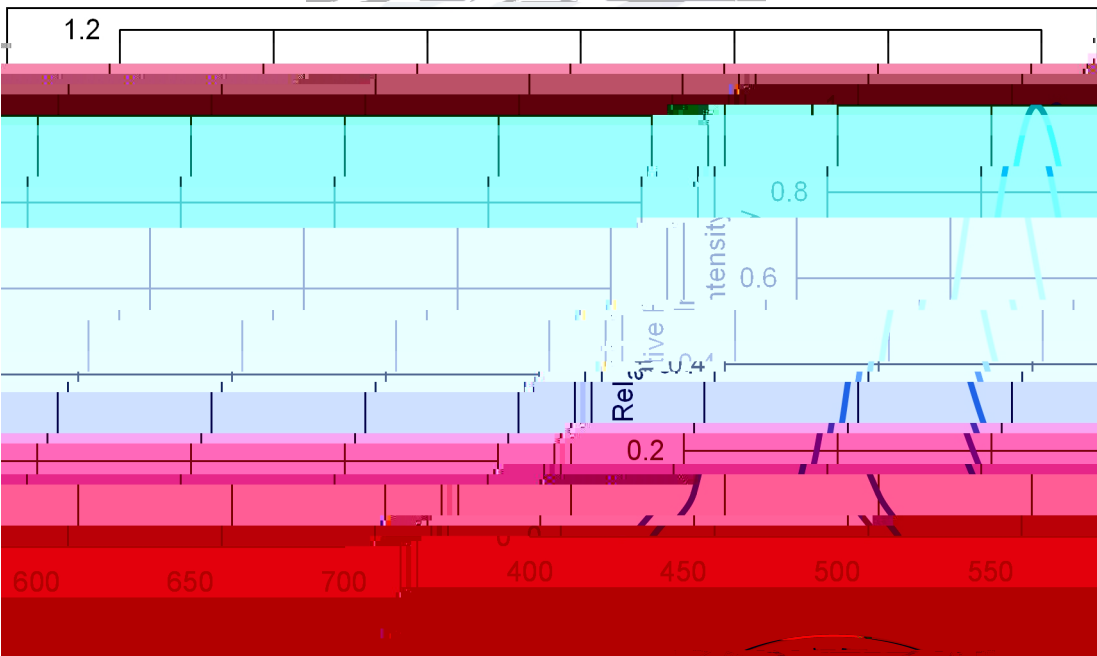
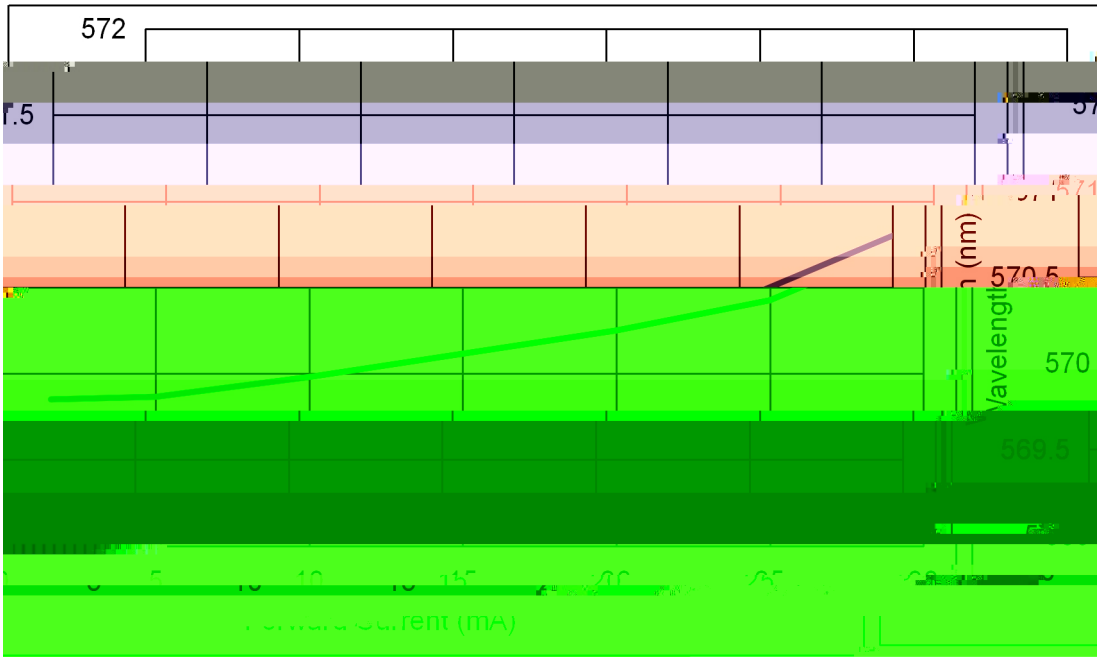

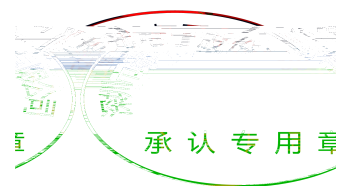
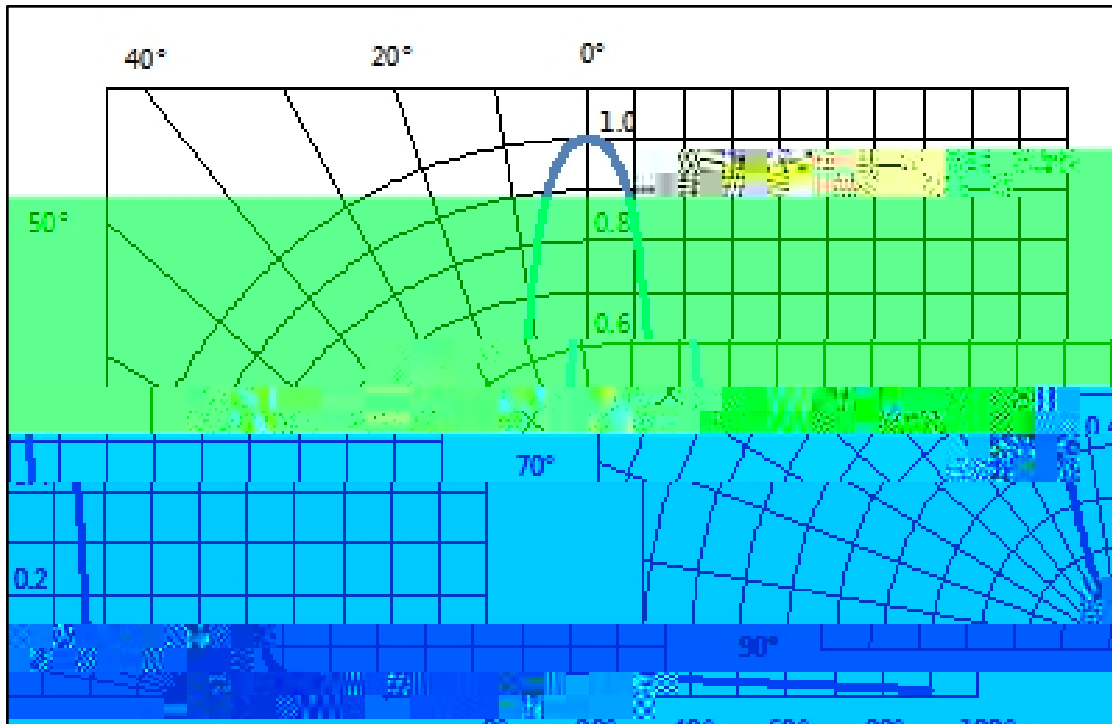
 承认专用章







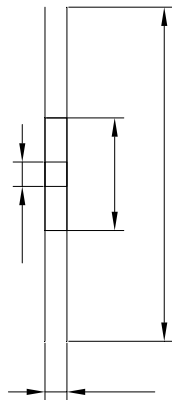
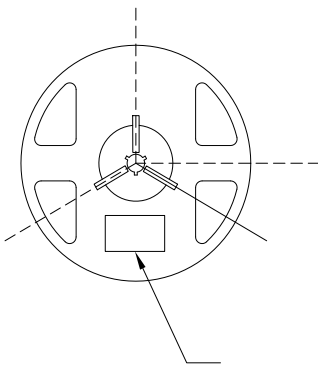
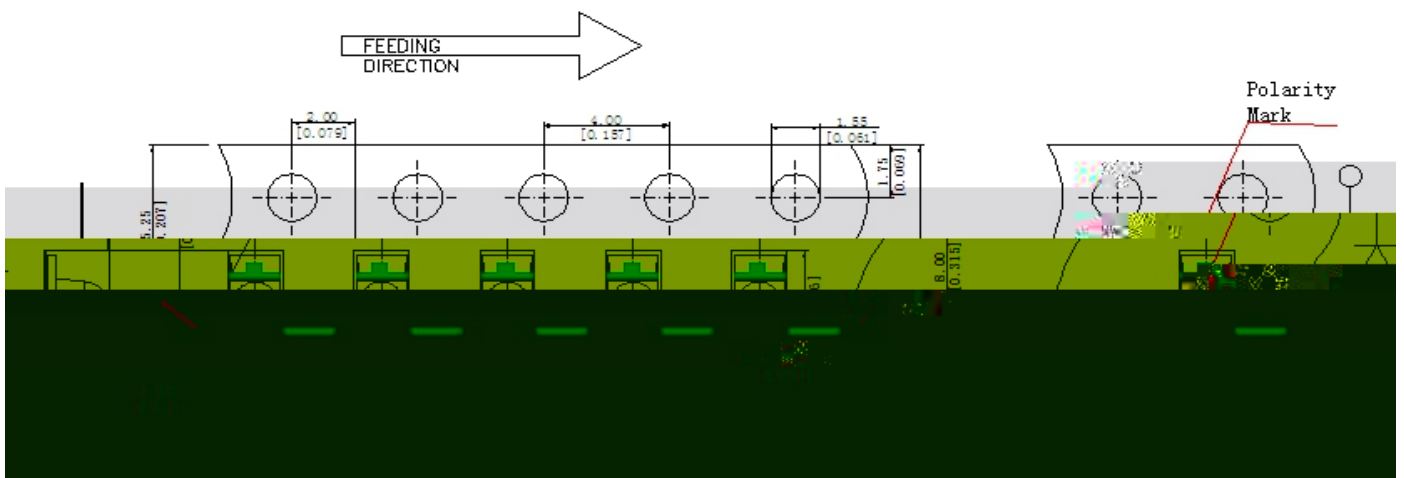

## 2.

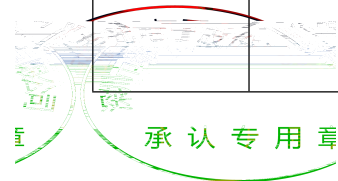
### 2.1



PART NO:	
SPEC NO:	
LOI NO:	
BIN CODE:	
IV:	
VF:	
	WLD:
	Qty:
	Date:





2.2

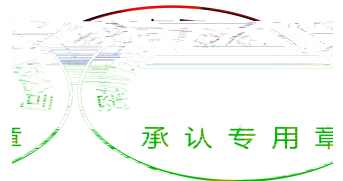
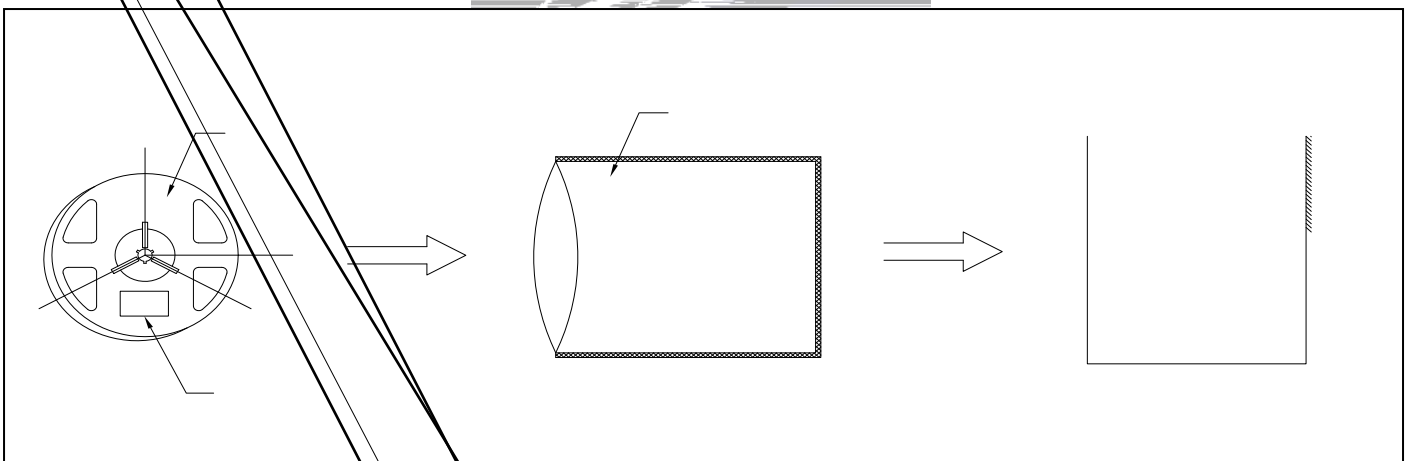

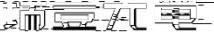

世通云商

REFORD



## 2.5







世通云商

REFORD

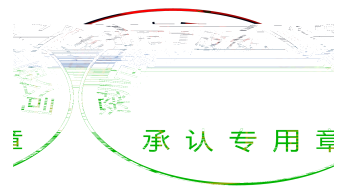
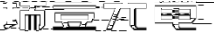

## 4. |

### 4.1 |

