

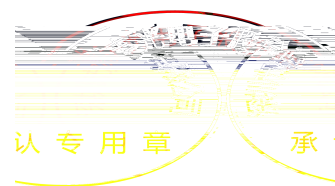

3  
3  
3  
3  
4  
4  
7  
10  
11  
  
12  
13  
13  
14  
15  
15  
17  
17



# 1.

## 1.1 General Description

## 1.2

## 1.3

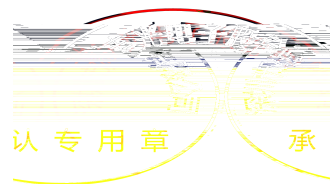

### 1.4

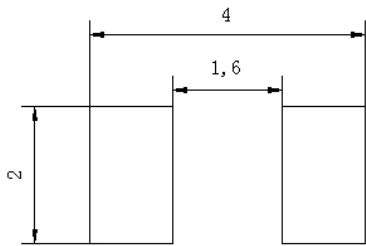
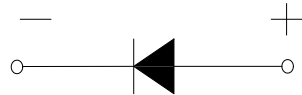
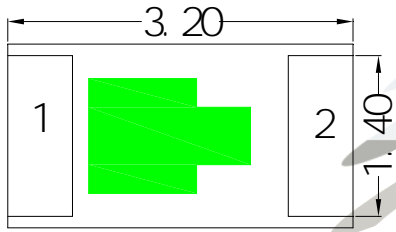
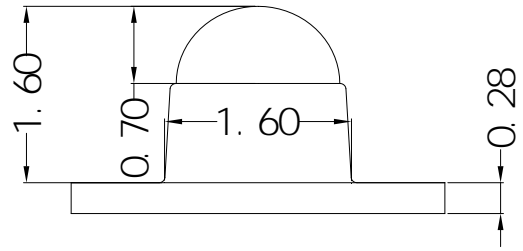
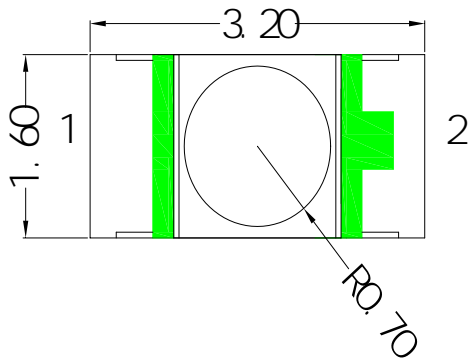

2.

±

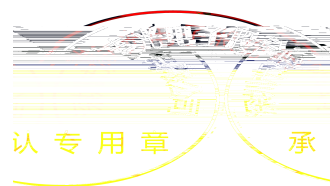

1.5

						mcd
						mcd
						mcd
						mcd
						mcd
						μ

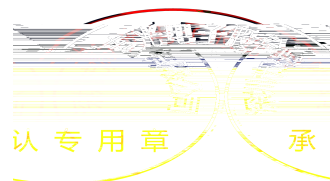

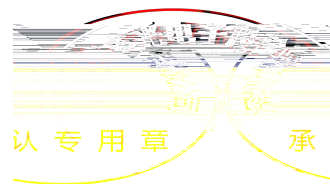

REFORD

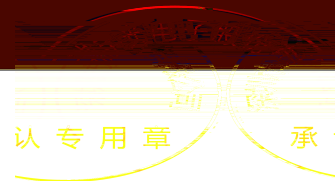
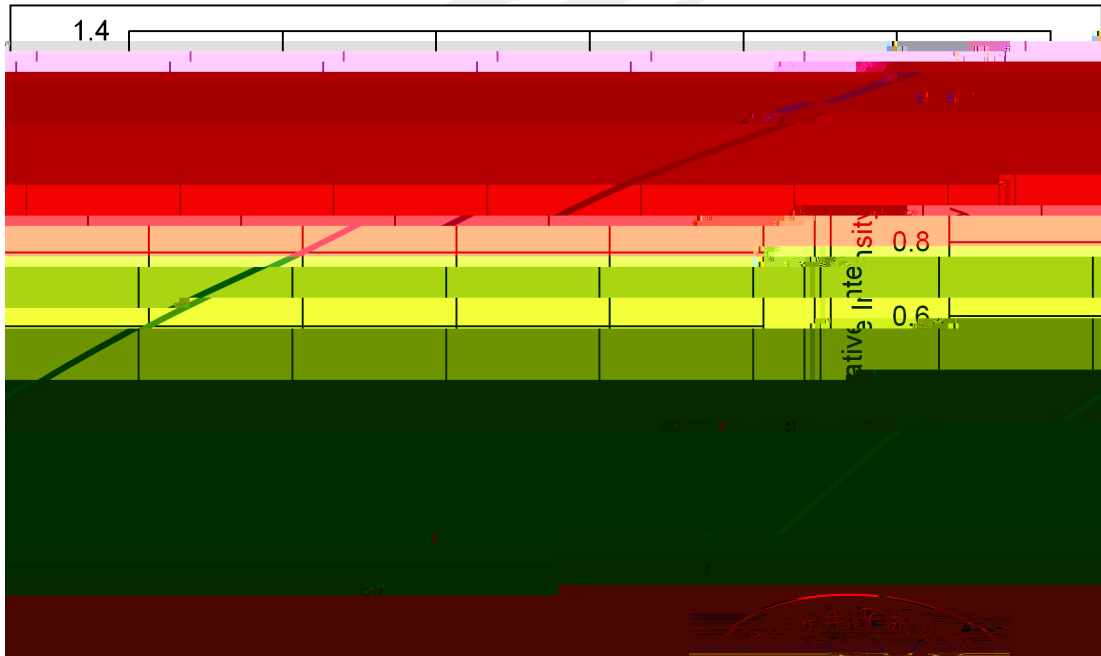
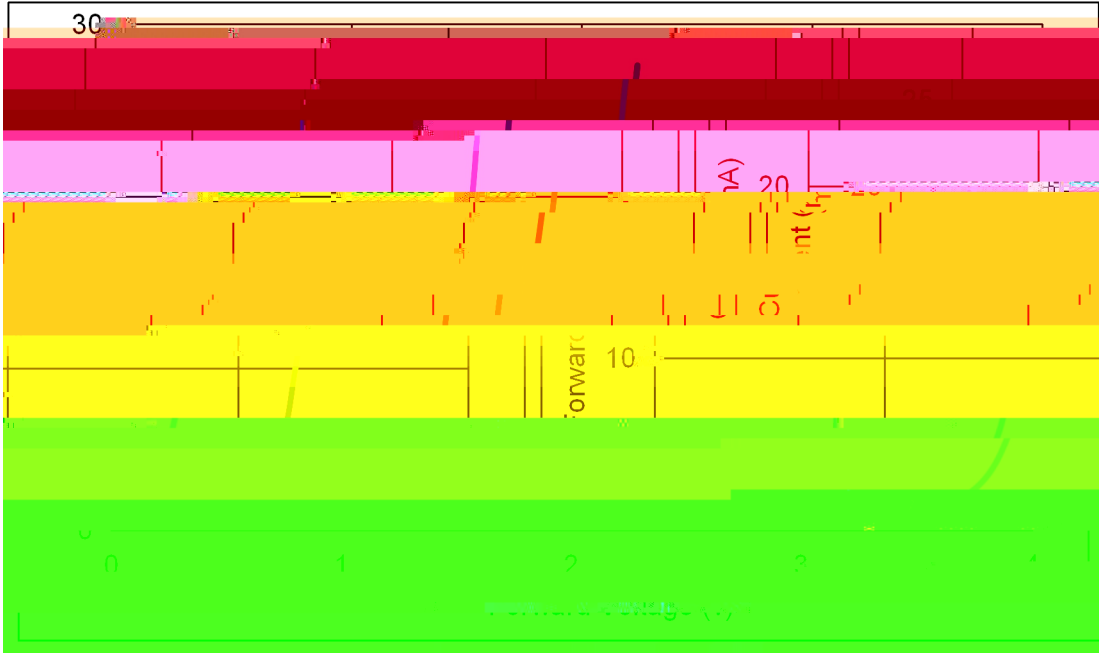

1.

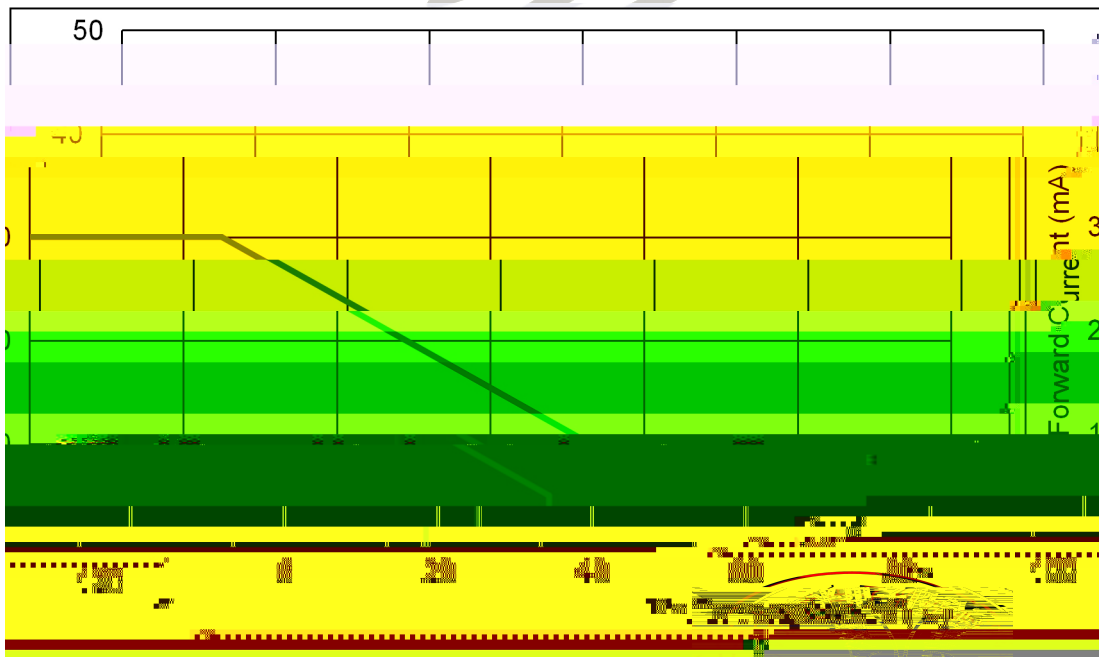
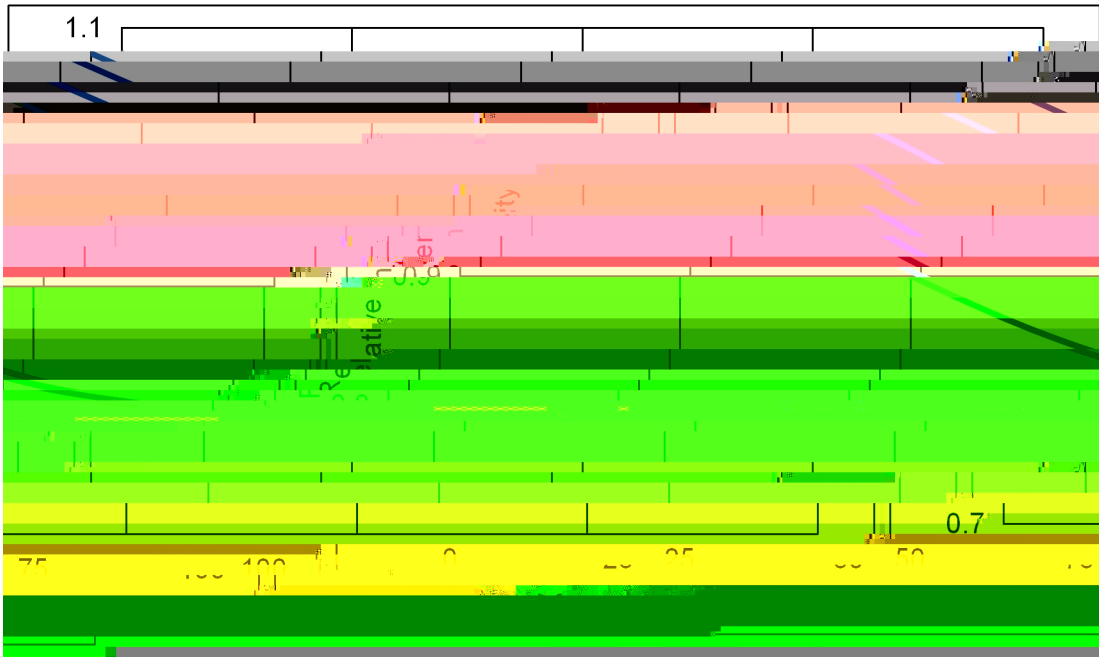



认专用章 承

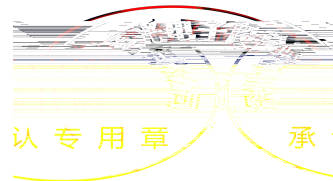
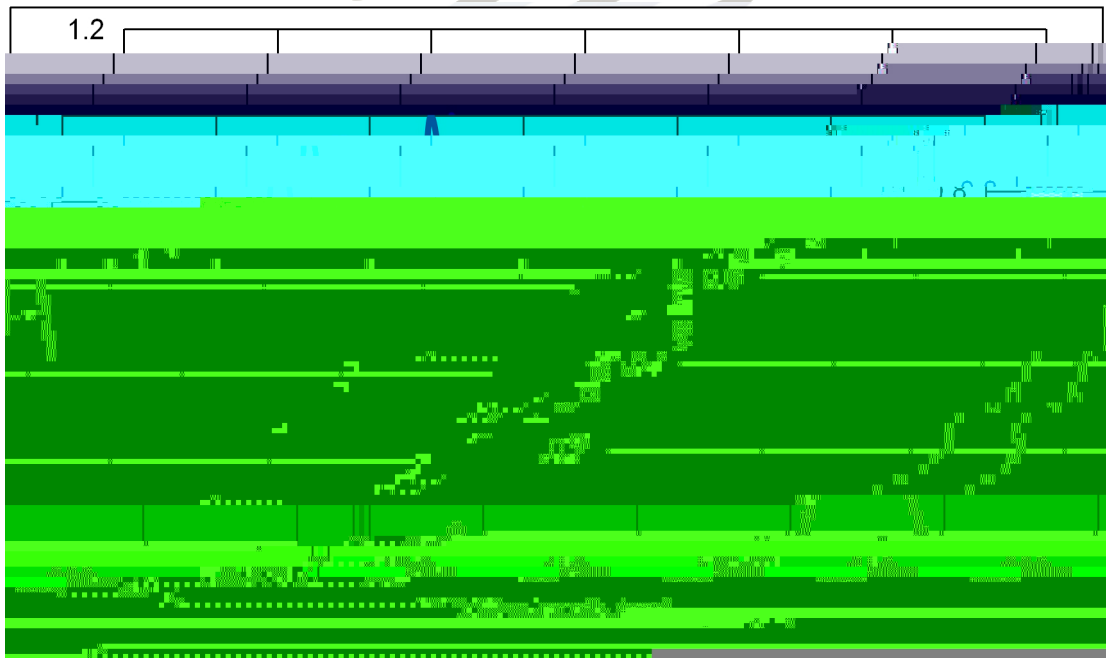
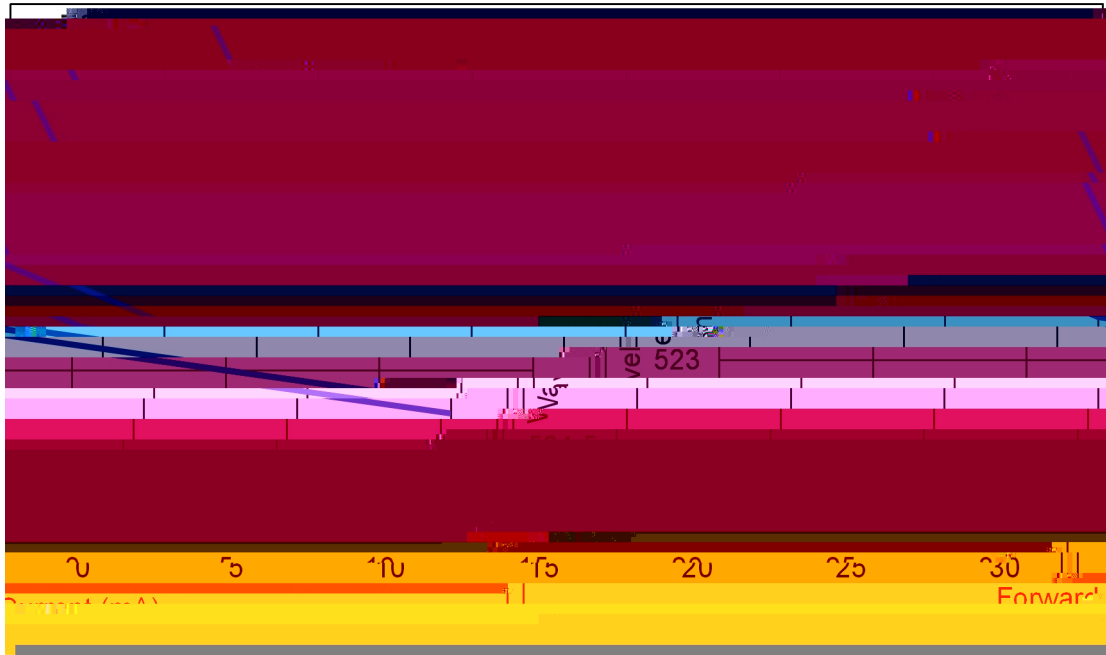

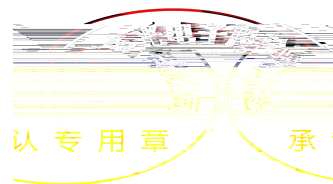
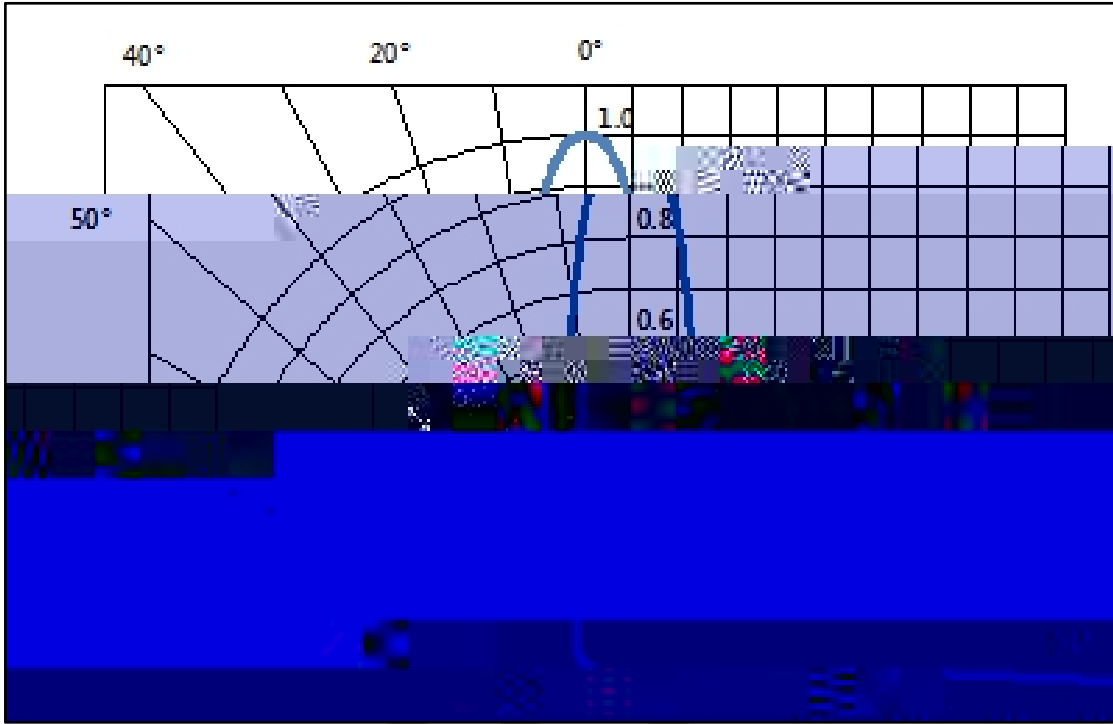

## 2.

### 2.1

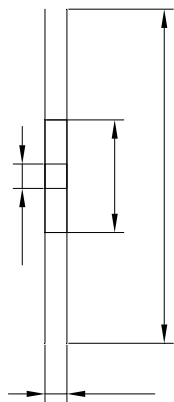
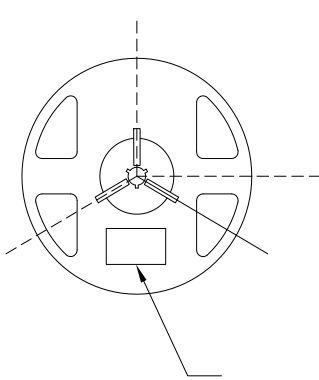
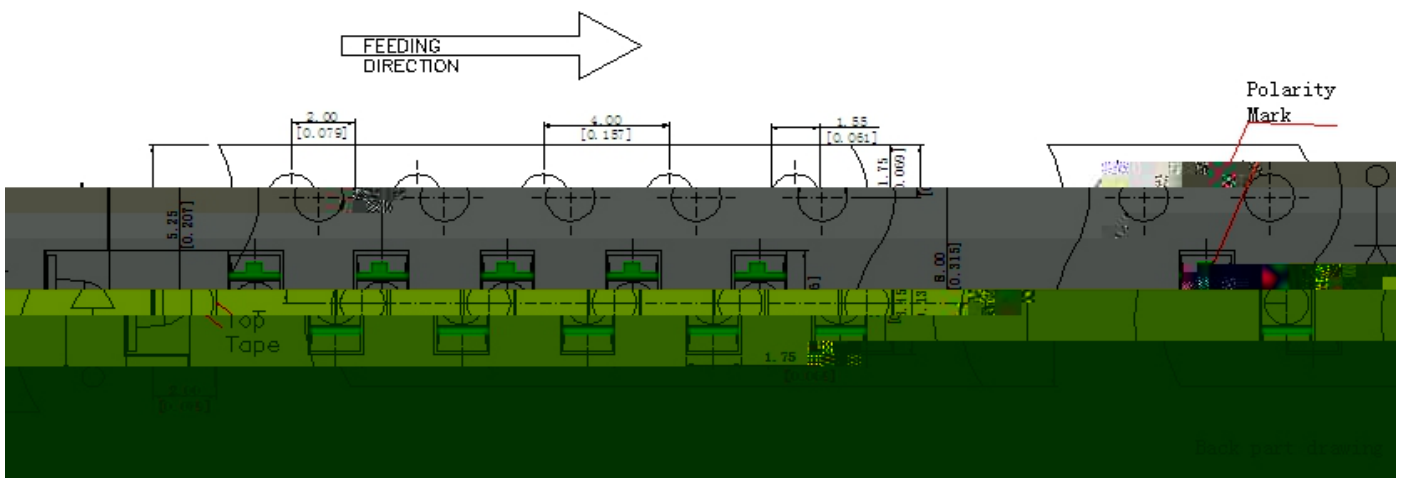

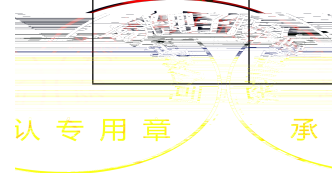

---

---

---

---

---

---

---

---

---

---

## 2.2

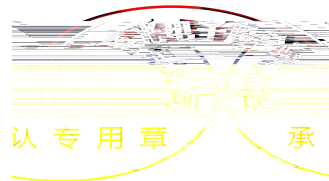
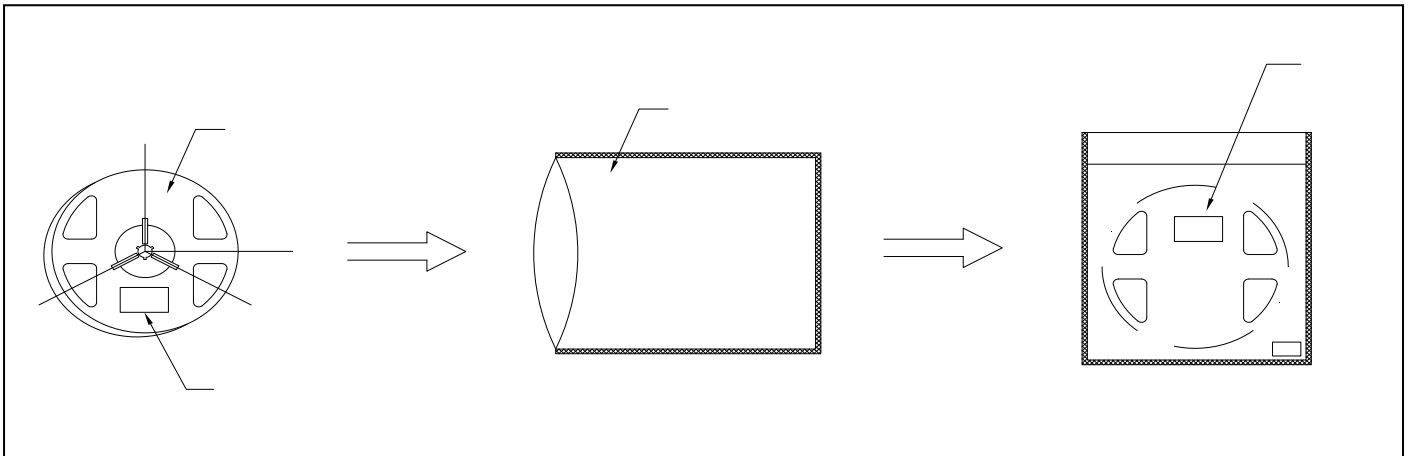

### 2.3

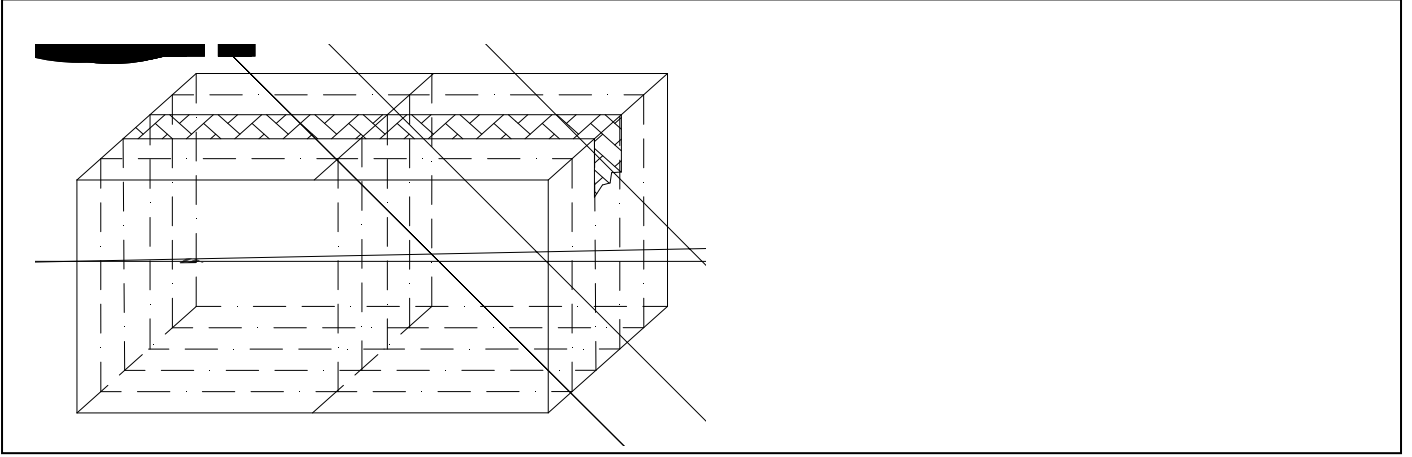

### 2.4

## 2.5





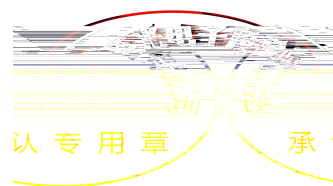

# 4.

## 4.1

Δ KHB b + e%#JIE

MKB

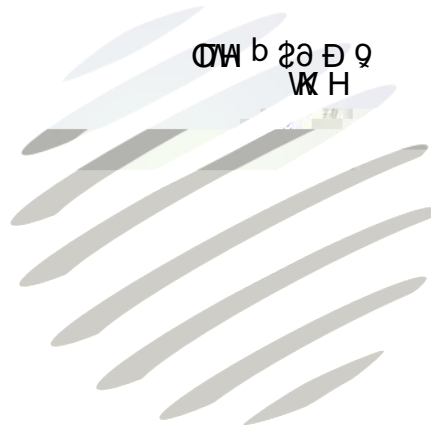

OW b 20 D 9  
KH

DA SKHO

BWM

M

FO D α

D

新加坡

OC

M

M

ΘAQBK



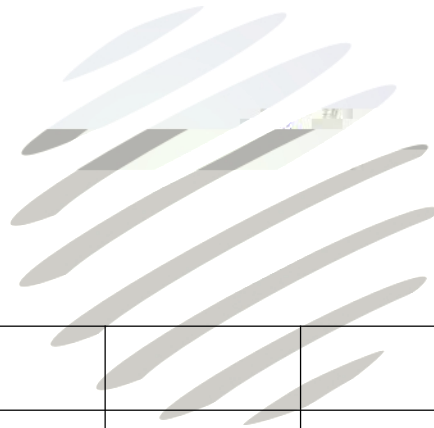

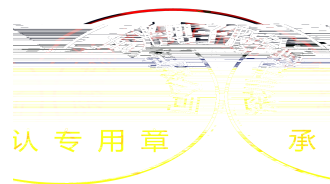

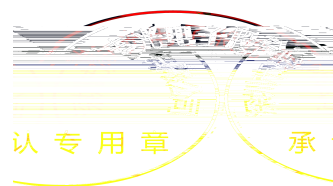





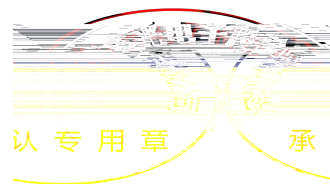

REFORD



认专用章

承·