

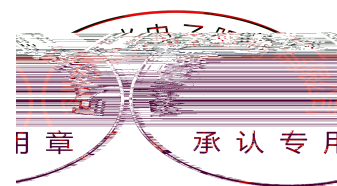

	3
	3
	3
	3
	4
	5
	7
	11
	11
	12
	13
	13
	14
	15
	15
	17
	17

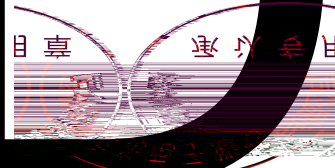

REFOND



U

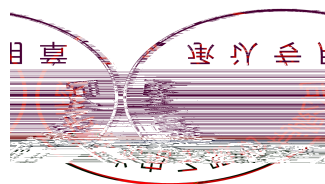

			°C
			°C
			°C

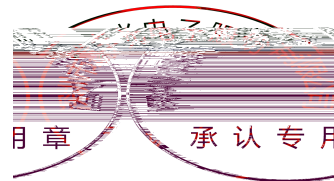
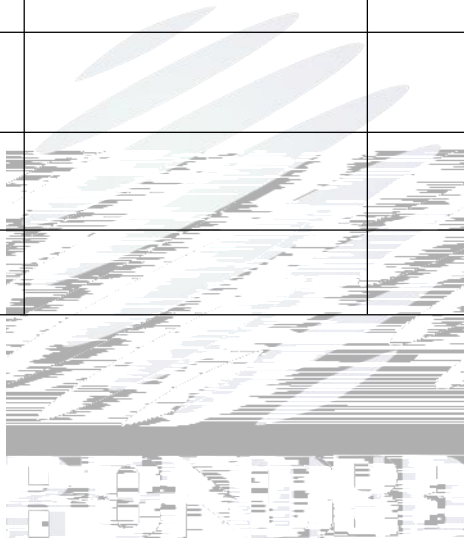

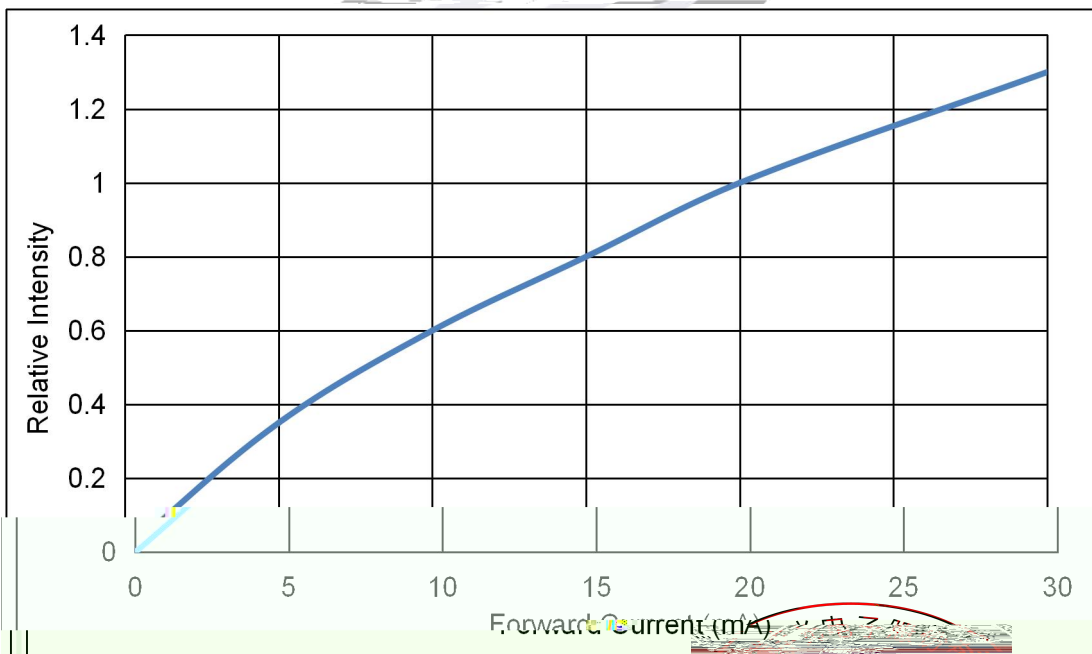
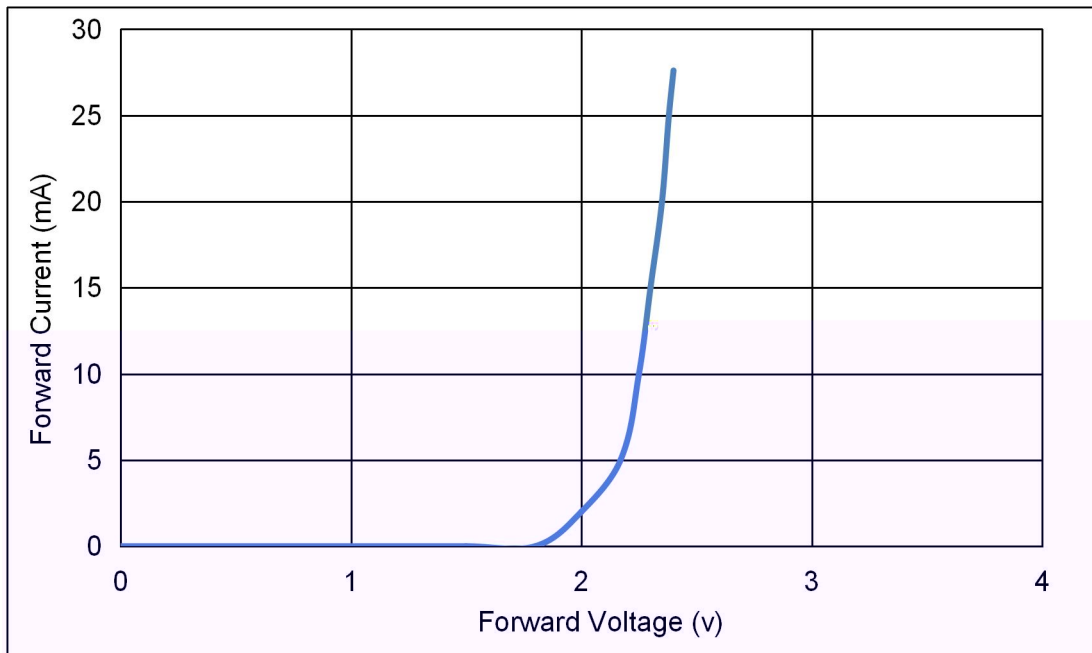

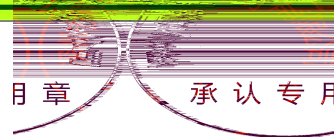
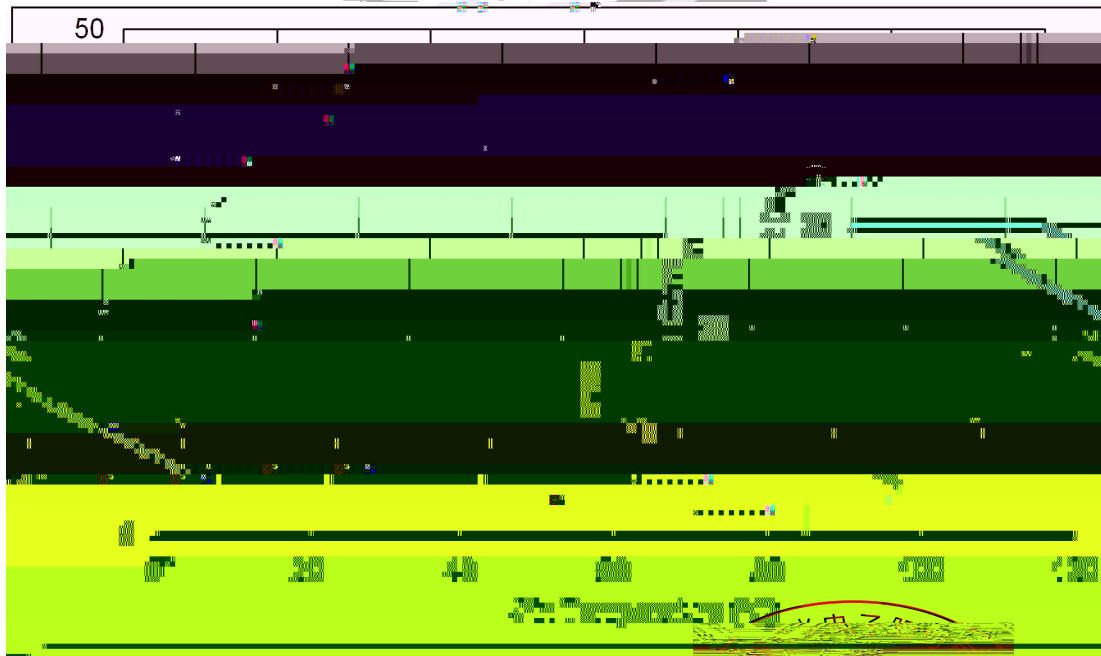
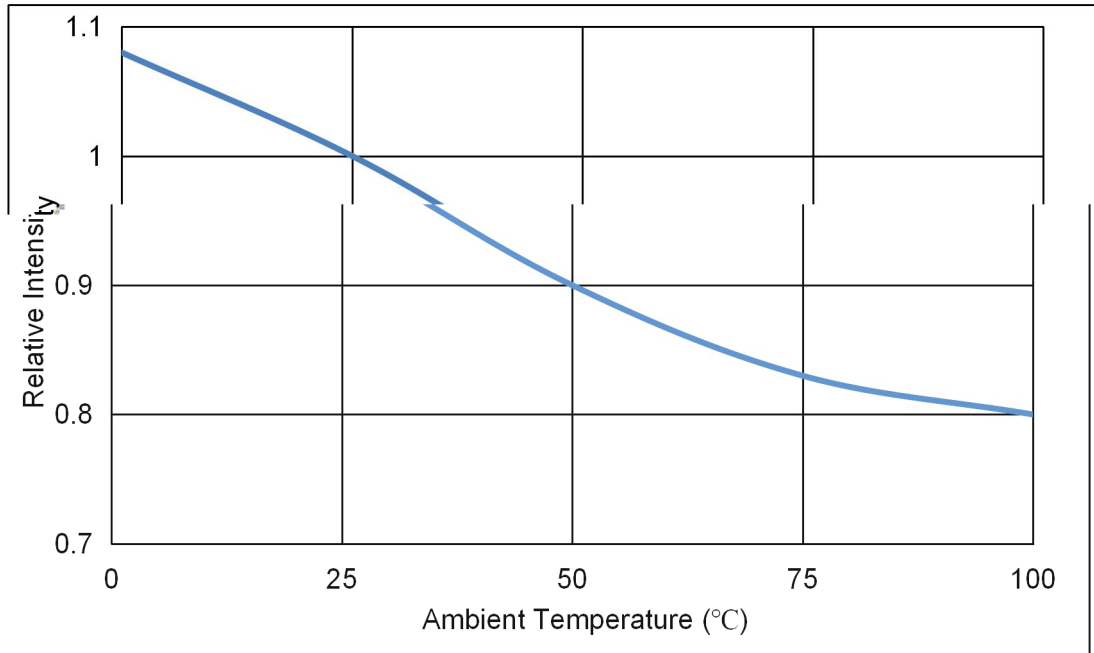

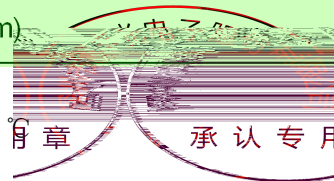
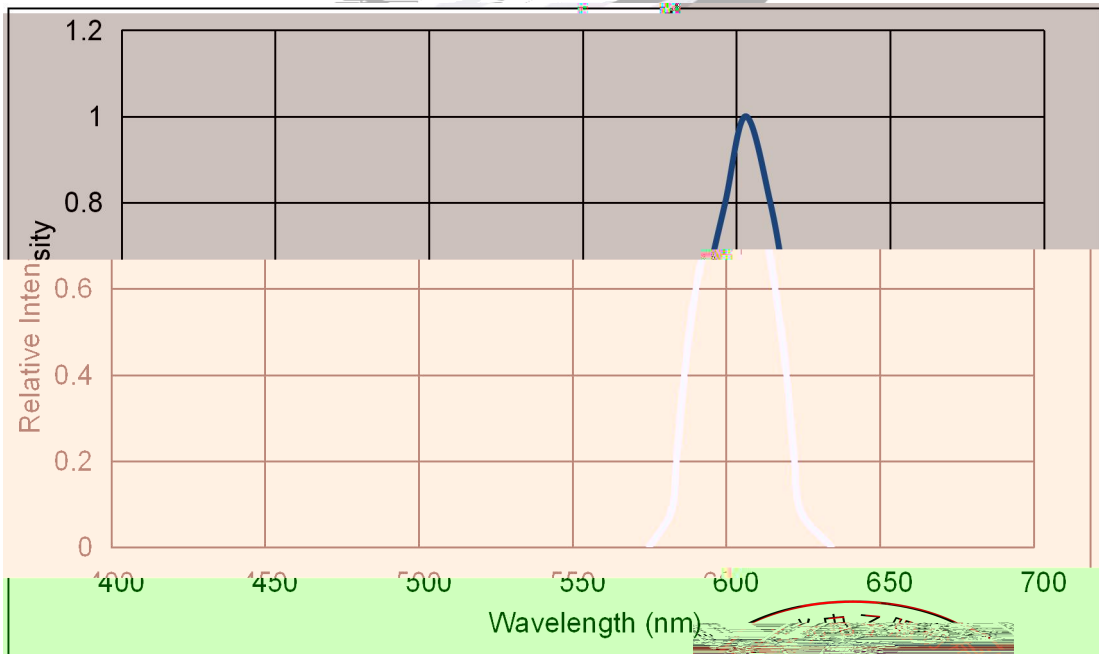
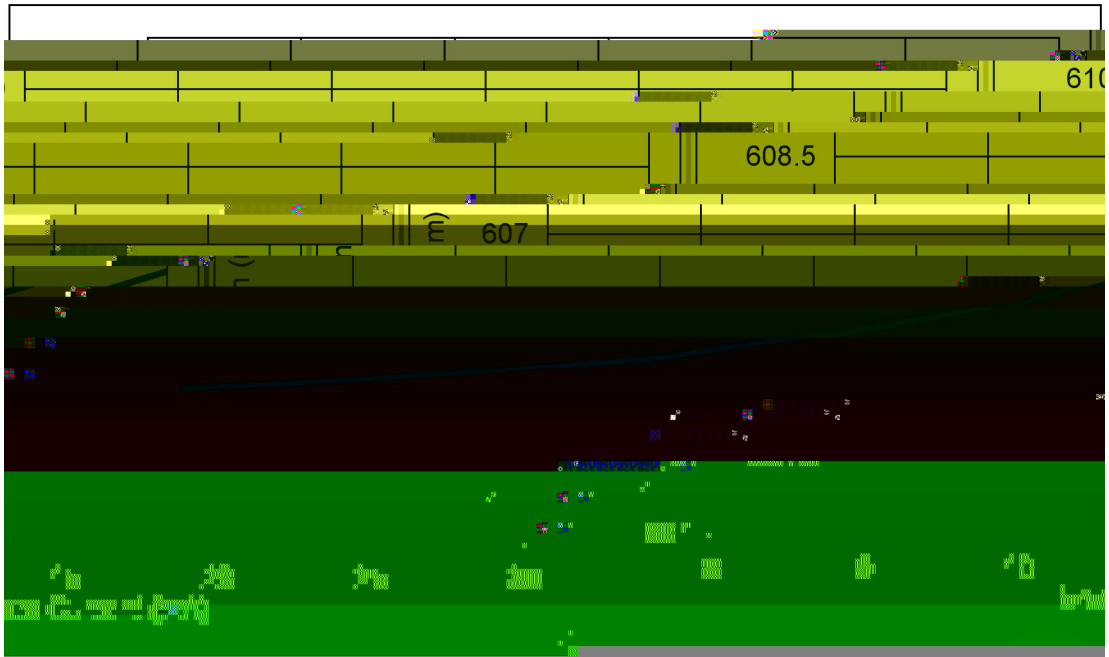

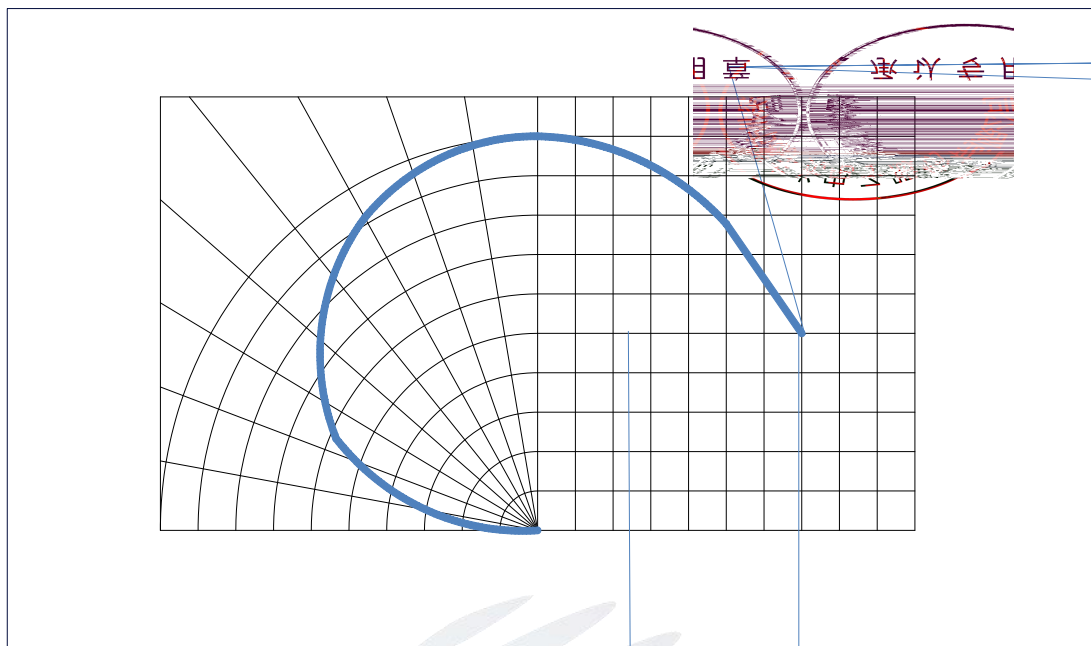

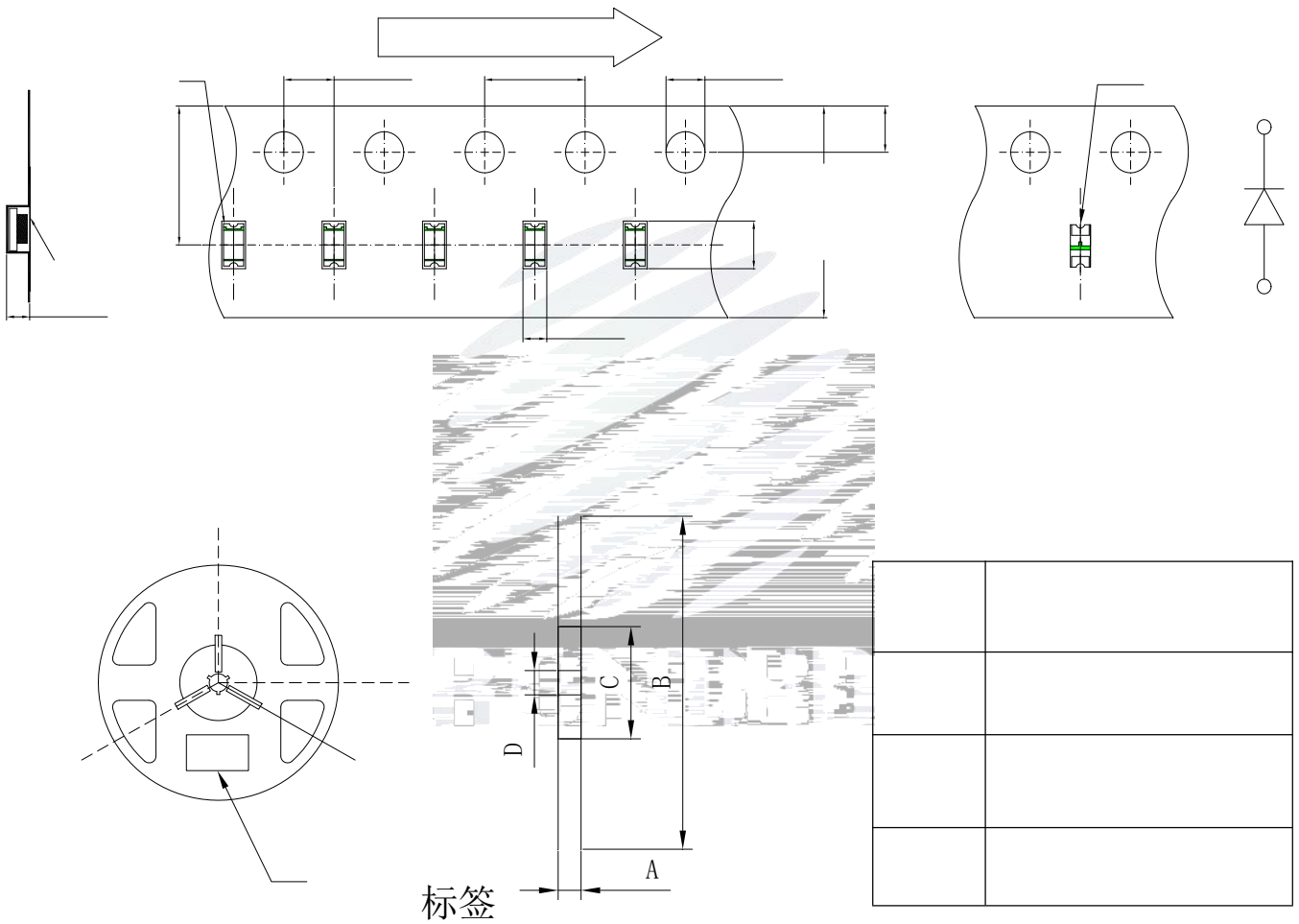



PART NO: SPEC NO: LOT NO	
BIN CODE: Φ: VF:	XY: WLD:
	QTY: DATE:



⇒

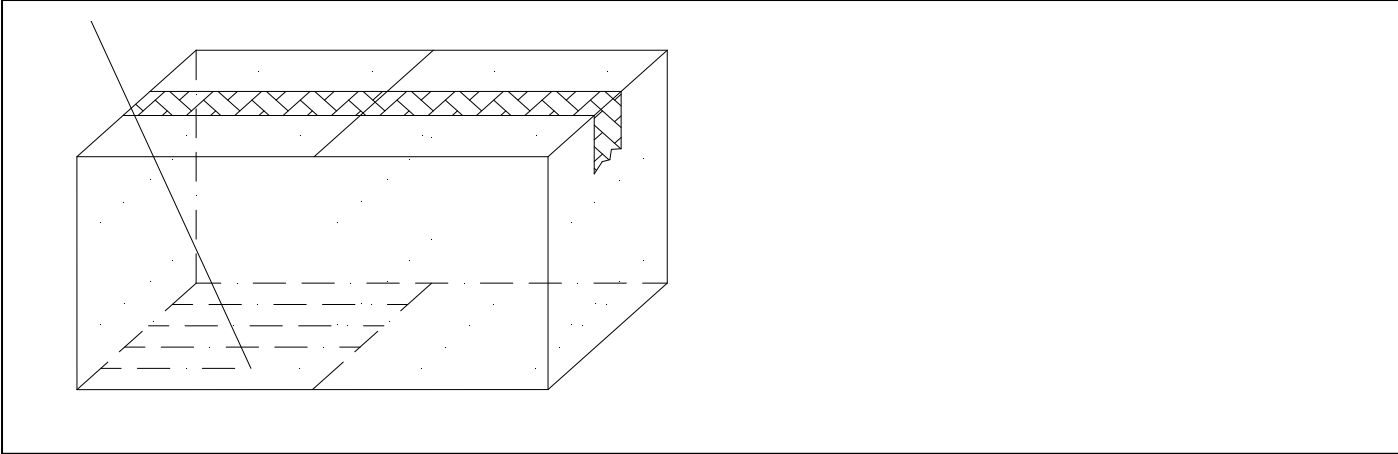

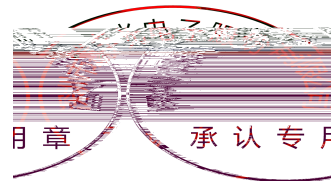
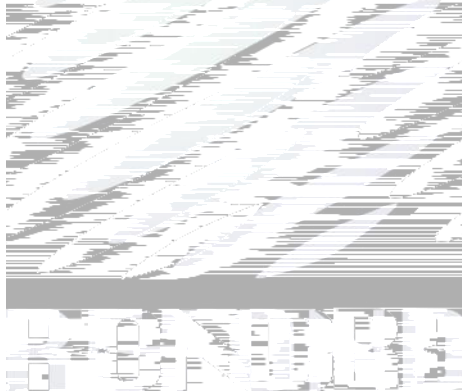

°C





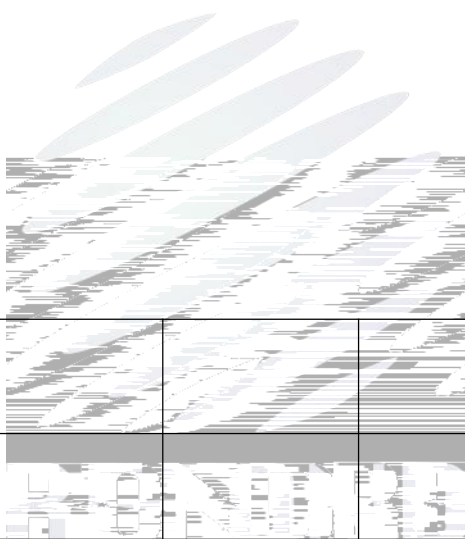

()

,
() °C





