

ECIFICA I

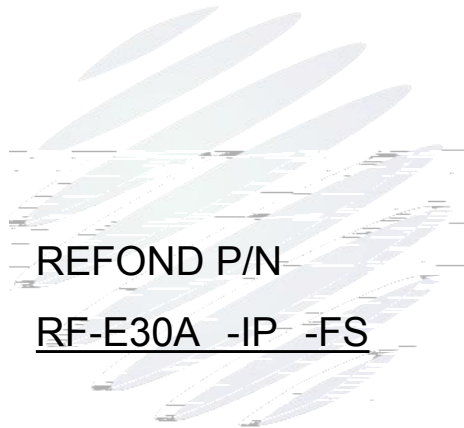

REFOND P/N

RF-E30A -IP -FS

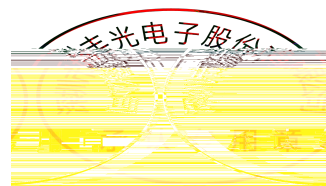

C



- 1. D
- 1.1
- 1.2 F
- 1.3 A
- 1.4 P D
- 1.5 P P
- 1.6 T
- 2. P
- 2.1 P S
- C T D
- 2.1.2 R D
- 2.1.3 L F S
- 2.3 C B
- 2.4 R T I A C
- 2.5 C F J D
- 3. SMT R ...

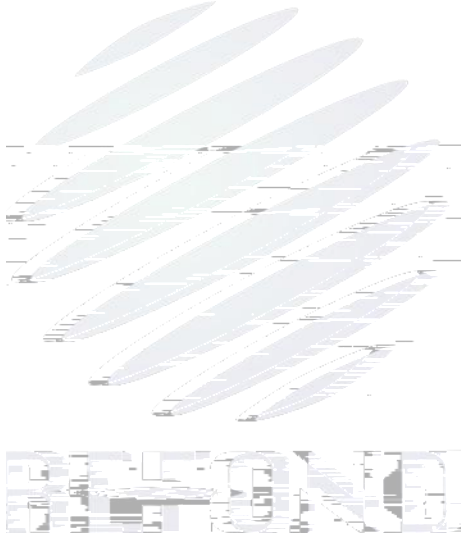

1. D

1.1

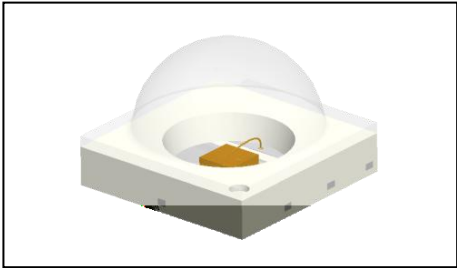

T EMC

S (): 3.00 3.00 2.10

EMC

3.00 3.00 2.10

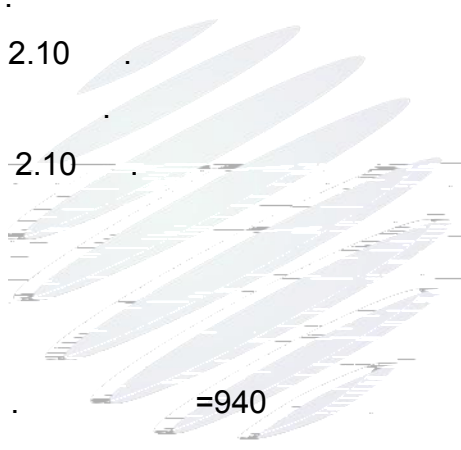

1.2 F

L

P

=940

=940

940

P -

M

:L 3.

L 3

R HS

R HS



1.3 A

S

I I

M

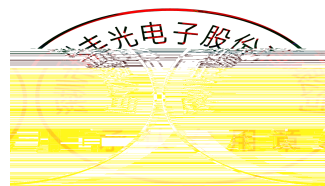

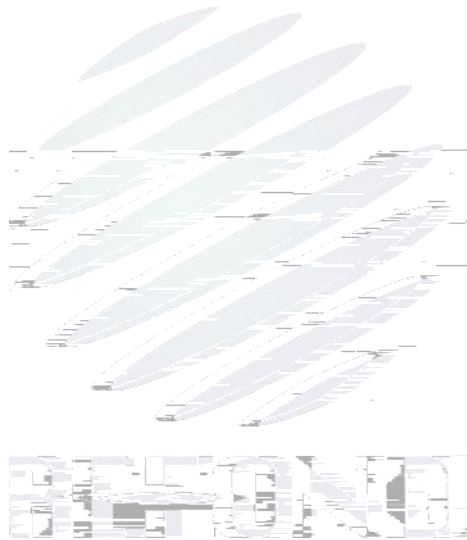

1.5

T 1-E I/O C T =25 C

I	S	T C				U
			M .	T	M .	
R C	I _R	R = 5	---	---	10	
F	F	IF = 500 A	1.3	1.5	---	
P	λ	IF = 500 A	930	940	---	
S B R		IF = 500 A	---	40	---	
T		IF = 500 A	140	255	---	
A	2 1/2	IF = 500 A	---	100	---	
T R	R _{THJ-S}	IF = 500 A	14			/

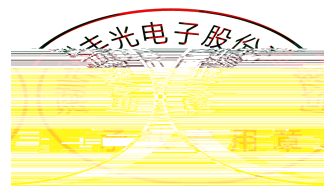

T 1-2 A M R T =25 C

P	S	R	U
P D	P _D	0.9	
F C	I _F	500	A
R	R	5	
E (HBM) D	E _{SD}	2000	
O T	T _{OPR}	-40 +85	
S T	T _{STG}	-40 +100	
J T	T _J	105	

N

1. I_F/10 D , 0.1

2. T 0.1

3. T T /R I : 10%.

4. C

5. A R

6. LED

7. ESD 90% 2000 ESD (HBM). ESD

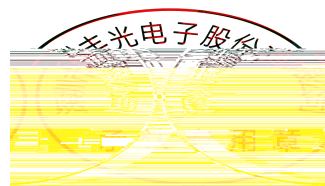

1.6

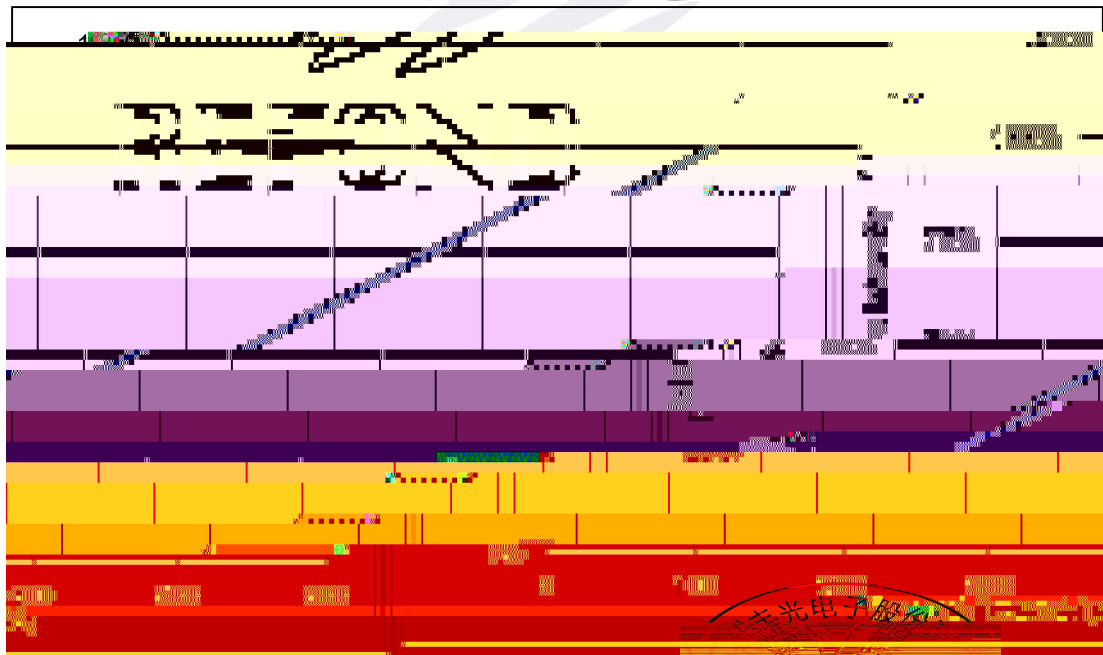
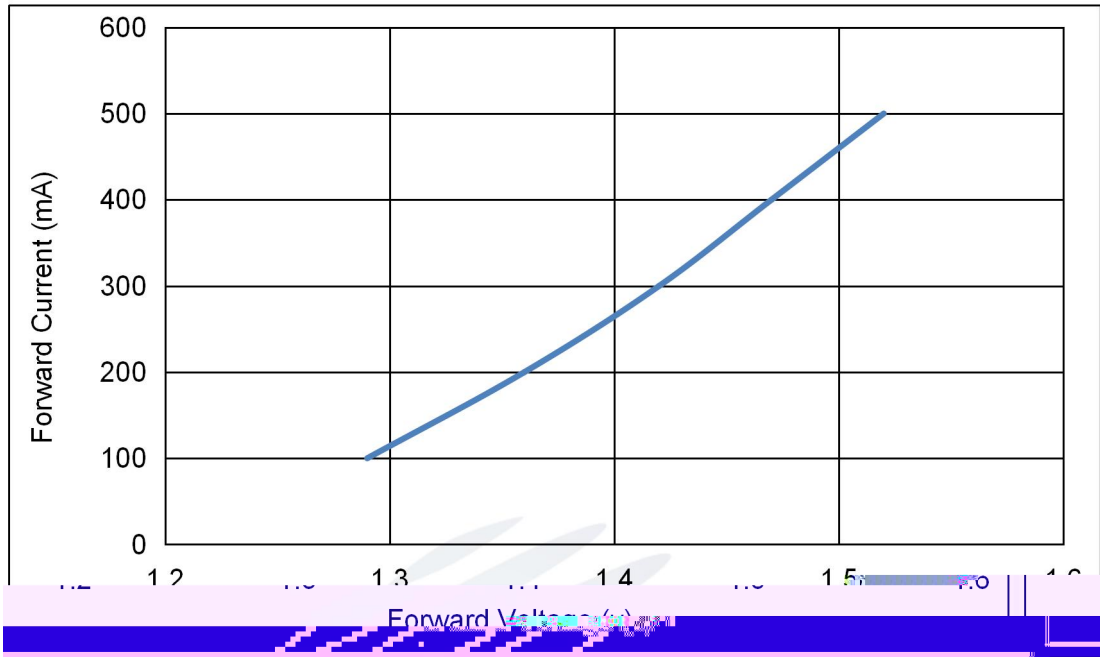

F 1-7 F C .R I

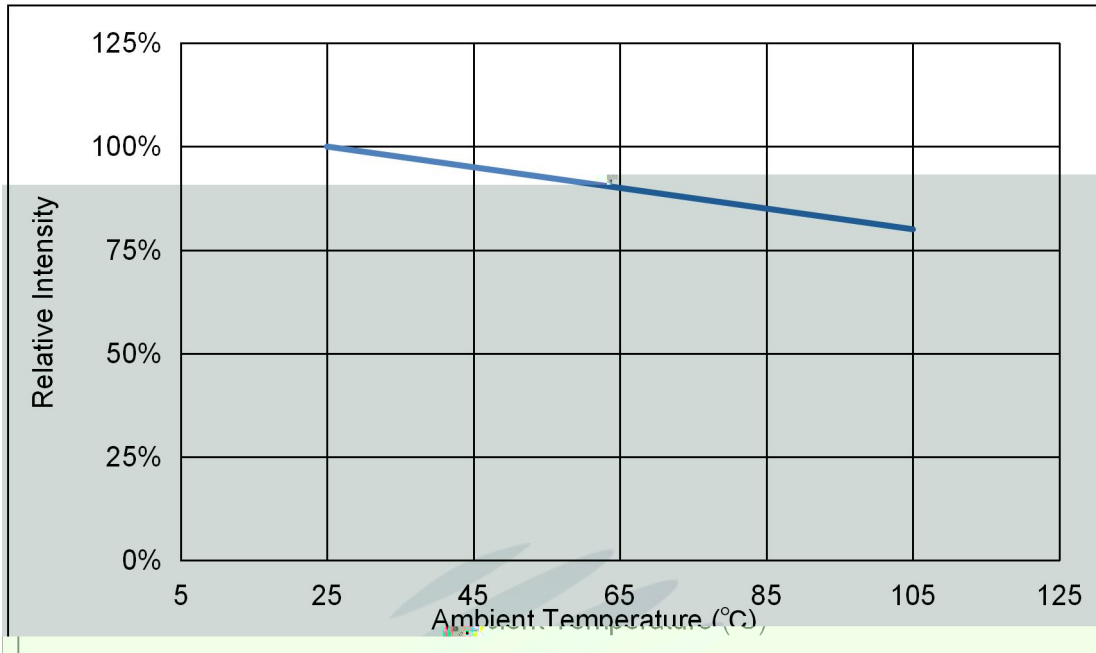

F 1-8 T T

R I

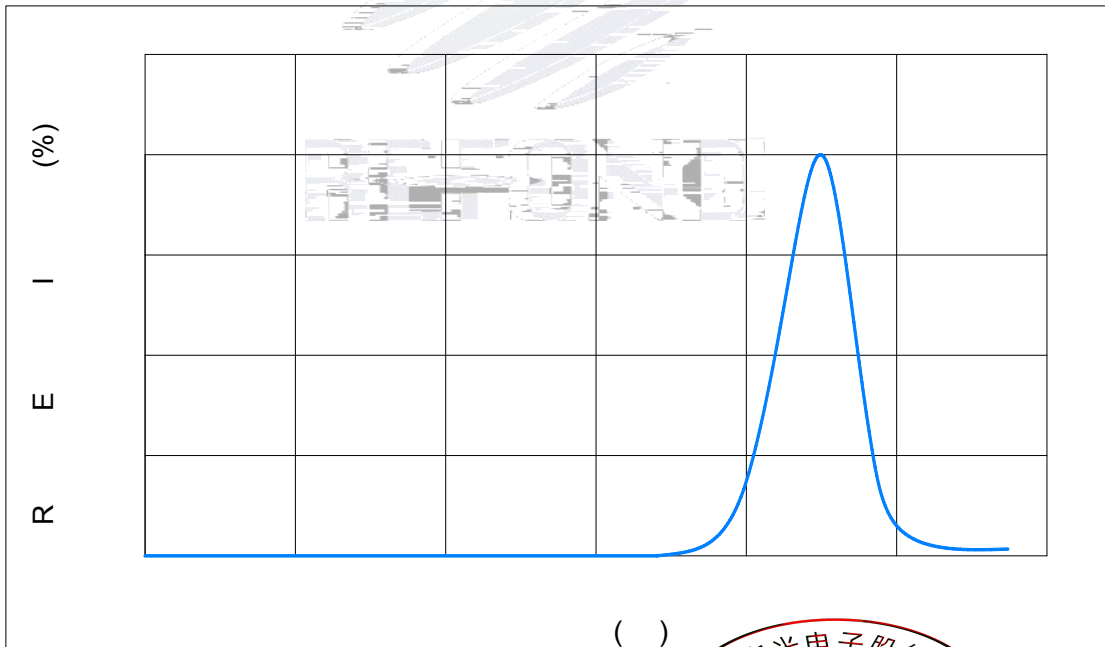

()

F 1-9 S

D

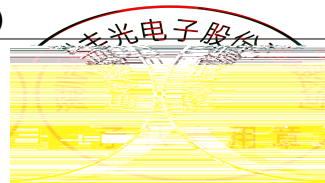

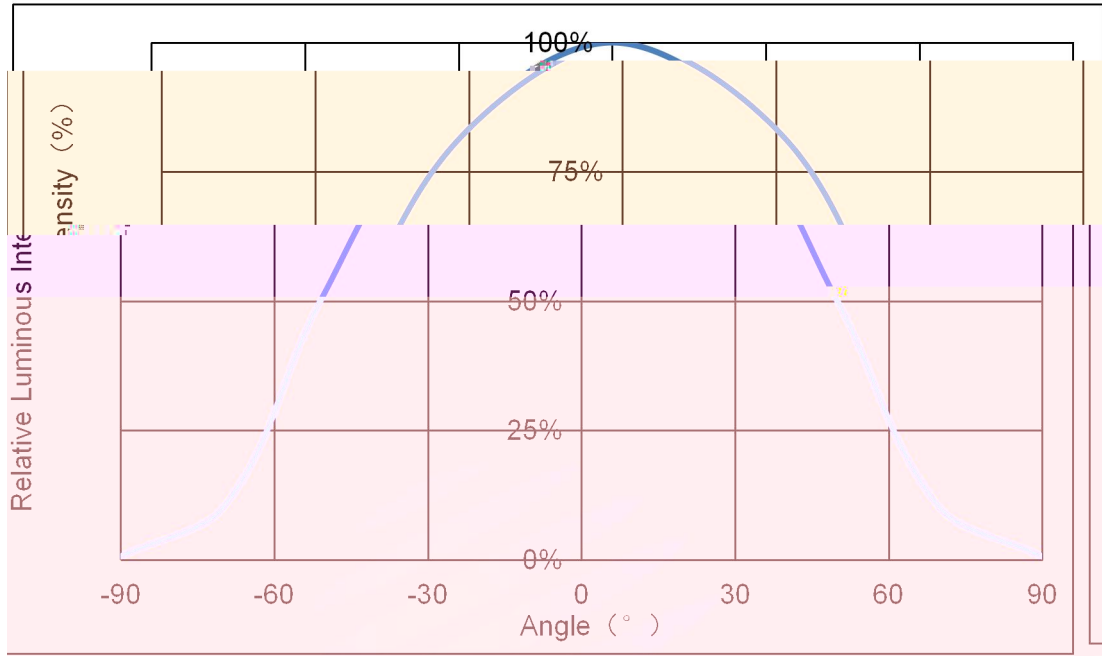

F-1-10 R

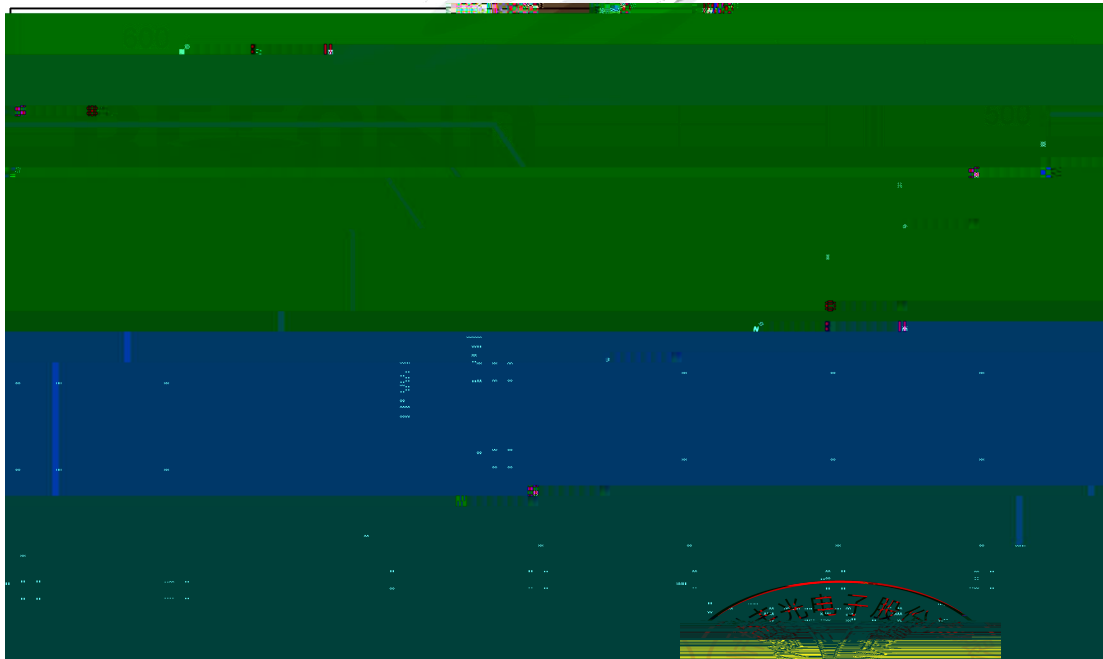

F-1-11 T T

F C

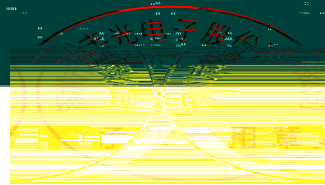

2.

2.1

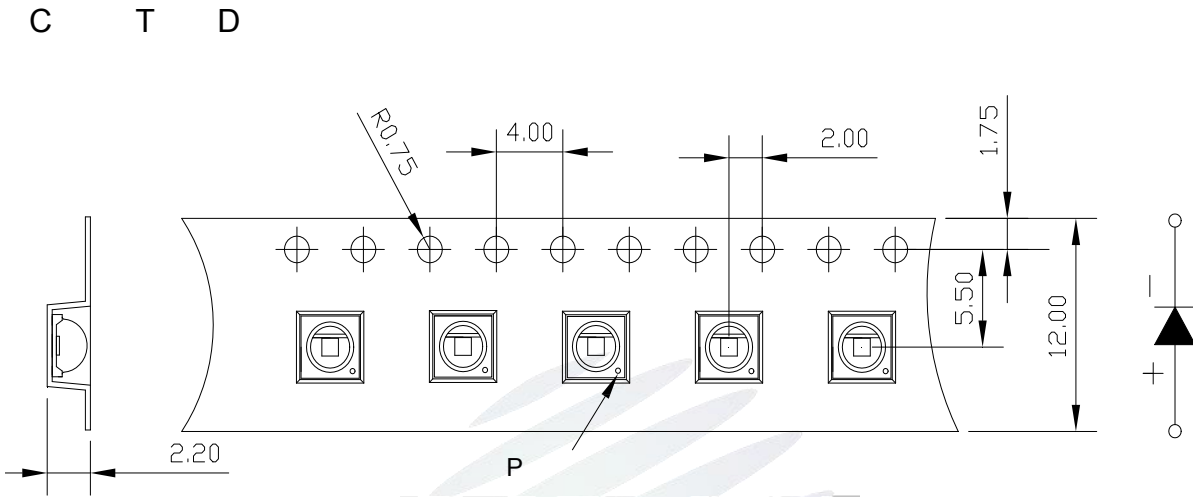

F .2-1 C T D

2.1.2 R D

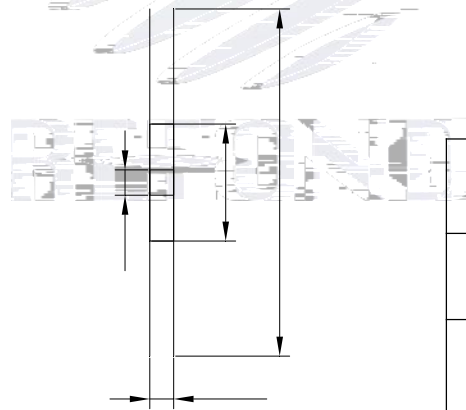
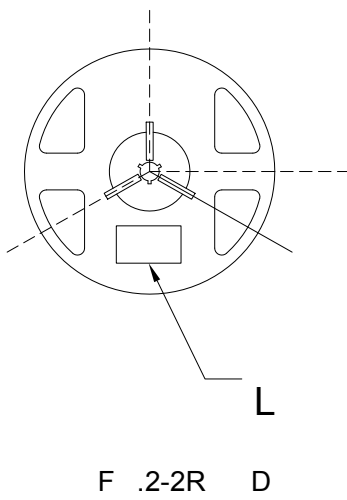

A	12.7 0.3
B	330.2 2
C	79.5 1
D	14.3 0.2

N

T

0.1 .U :

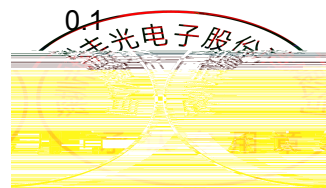

2.1.3 L F S

T 2-2 L F S

PART NO	P	N
SPEC NO	S	N
LOT NO	L	N
BIN CODE	B	C
	T	
LP	P	
F	F	
QT	P	Q
DATE	M	D

F 2-3 L F S

2.2 M R P

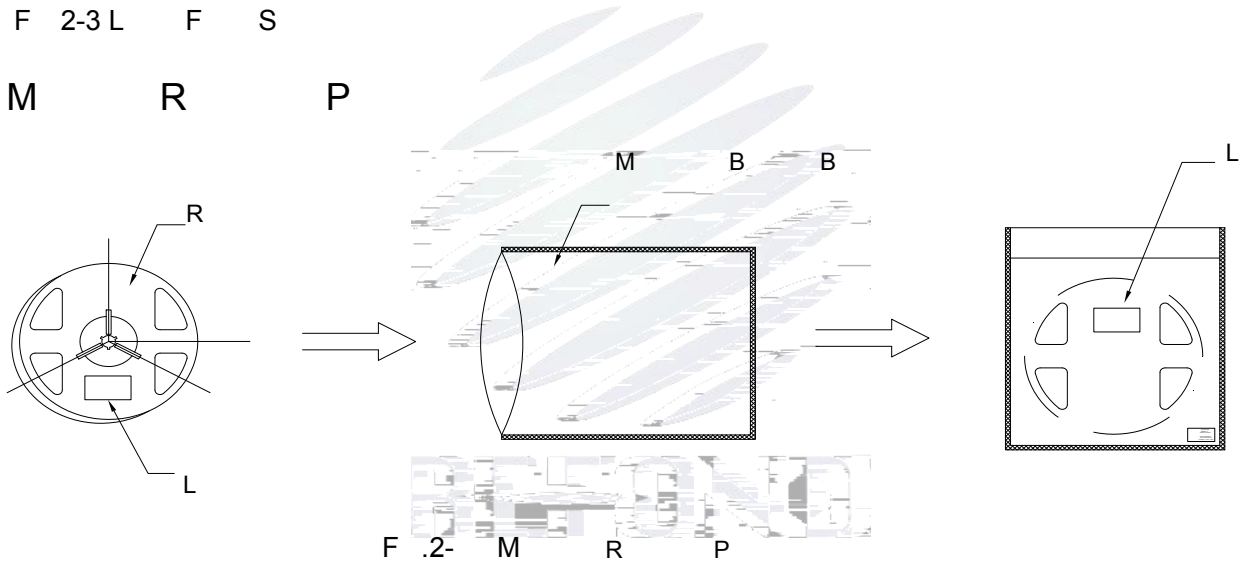

2.3 C B

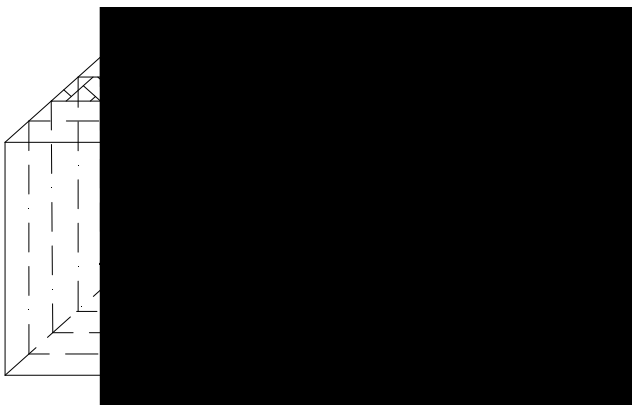

F .2-5 C B

2.4 I A C

T 2-3R T I A C

T I	R .S	T C	T	Q	A /R /
R	JESD22-B106	T :260 T=10	3	10P	0/1
T C	JESD22-A104	100 C 30 5 -40 C 30	100	10P	0/1
T S	JESD22-A104	-40 15 10 100 15	300	10P	0/1
H T S	JESD22-A103	T :100	1000	10P	0/1
L T S	JESD22-A119	T :-40	1000	10P	0/1
L T	JESD22-A108	T =25 If=500 A	1000	10P	0/1

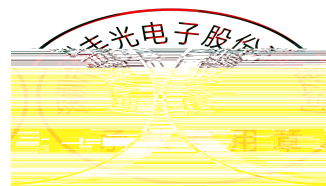

2.5 C F J D

T C F J D

T I	S	T C	C F J	
			M .	M .
F	F	$I_F=500 \text{ A}$	-	U.S.L*) 1.1
R C	I_R	$R = 5$	-	U.S.L*) 2.0
T		$I_F=500 \text{ A}$	L.S.L*) 0.7	-

N

1.U.S.L: U

2. T

LED



3.T

. I

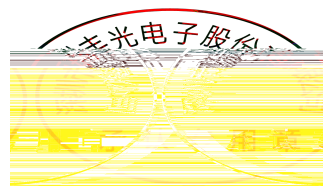

3. I

3.1 I

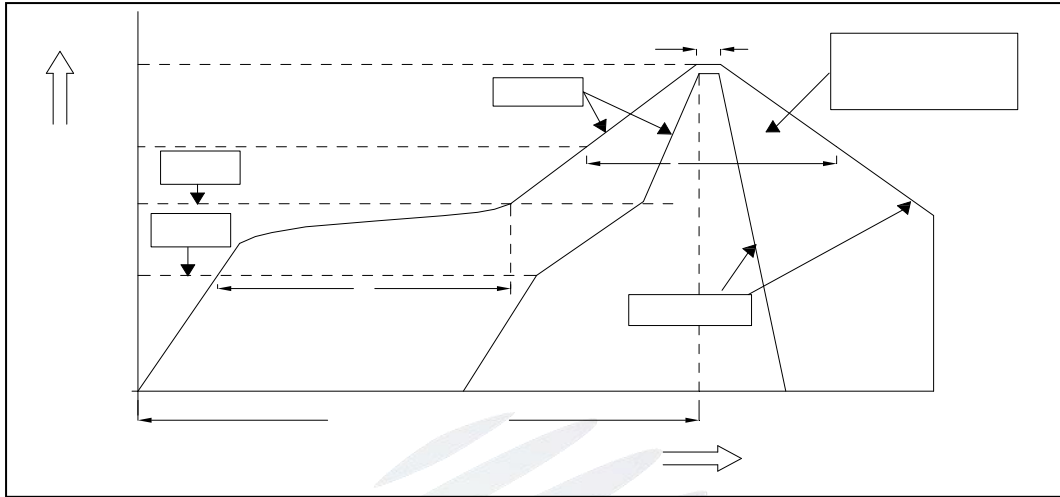

F .3-1 SMT R S I SMT

T 3-1 P

A	T	TP	3 C/	M	3 C/
P	:	(T)	150	C	
P	: M	(T)	200	C	
P	: T	T T	60 - 120	60 - 120	
T	:	(TL)	217	C	
T	: T T	(L)	60	M	60
P	/C	: / (TP)	260	C	
T			10	M	10
H	5 C	5 C (TP)	30	M	30
C			6 C/	M	6 C/
N	25 C	T 25 C	8	M	8

N

(1) R . I 24

, LED

(2) , LED

3.1.1 S I

(1) , 300 3

(2)T

3.1.2 R

R

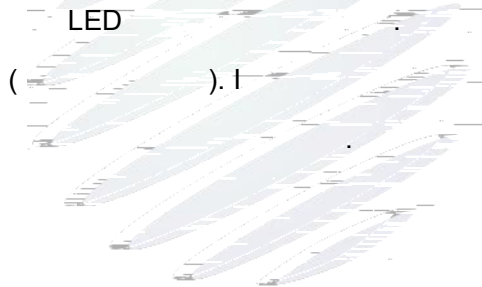

LED

LED

3.1.3 C

T



LED

T

LED

. T

LED . P

. S

. LED

(2) C

()

PCB. A

.LED

(3) D

. D

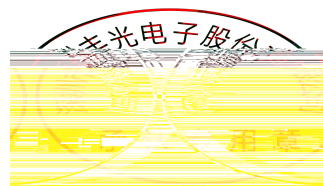

4. H

4.1 H

(1) LED

100PPM

LED

. T

.LED

(2) I

LED,

LED,

B

900PPM,

C

900PPM,

B

C

1500PPM. T

(3) OC (

)

LED

. T

. K

. R

. T

, R

. A

LED ,

(4) H

;

H

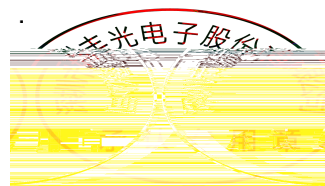

F 4-

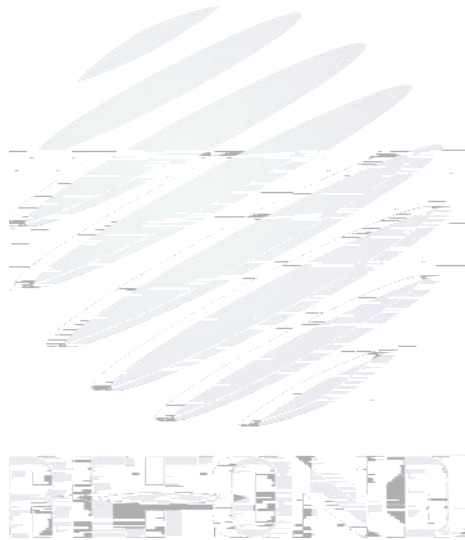

T 4-1 S

C				T	H	T	
S	B	O	A	B	30	75%	1 F D
	A	O	A	B	30	60%	168 168
B				60 5	-	24 24	

(8) I



LED

60 5

24

I



(9) S

S

; LED

E

-S

D

(ESD)

E

O S

(EOS).

(10) O

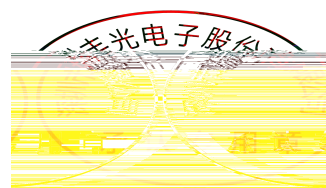



D
T

E

C

