

# SPECIFICATION

REFOND P/N

RF-W1SA21IS-N48

Mass Product





4.1.5 Directionsfor Use	20
4.1.6 Others	22
4.1.7 Declare	23



## 1. Description

### 1.1 General Description

The product is a full-color LED device, Common cathode RGB SMD, High contrast (Surface brush ink technology),The product size: 2.05mmX2.15mmX1.9mm.

LED

RGB SMD

2.05mm000008871 0 595.32 842.04 reW\* n000 0 E0 g0 G[ )]TJETQ EMC /Span #MCID 14/Lang (en-US)



## 1.4 Package Dimension

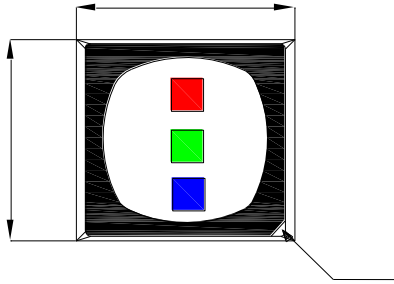

Fig.1-1 Top view

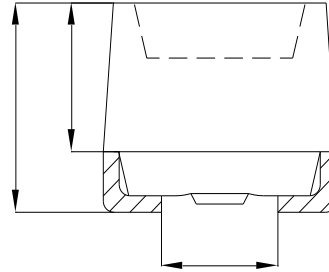

Fig.1-2 Side view

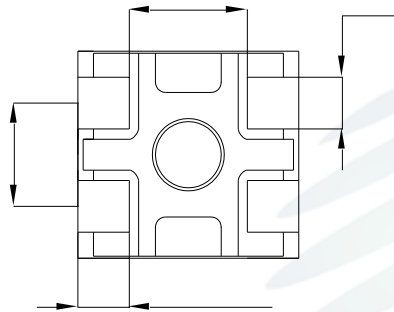

Fig.1-3 Bottom view

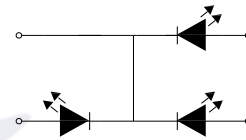

Fig.1-4 Polarity

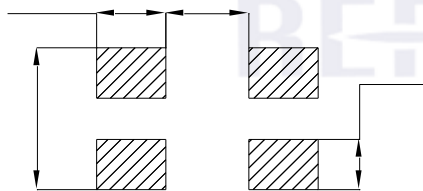

Fig.1-5 Soldering patterns

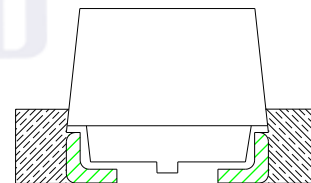

Fig.1-6 Glue filling

### Notes

All dimensions units are millimeters.

All dimensions tolerances are  $\pm 0.1$ mm unless otherwise noted.



## 1.5 Product Parameters

Table 1-1 Electrical / Optical Characteristics at Ts=25°C

Item	Symbol	Test Condition	Value			Unit
			R	G	B	
Reverse Current	$I_R$	$V_R=5V$	6	6	6	
Forward Voltage	$V_F$ (min)					

R  
 $I_F = 15$



Notes

1. The above forward voltage measurement allowance tolerance is  $\pm 0.1V$ .
2. The above Tolerance of measurement of dominant wavelength  $\pm 1nm$ .
3. The above luminous intensity measurement allowance tolerance  $\pm 10\%$ .
4. Care is to be taken that power dissipation does not exceed the absolute maximum rating of the product.
5. All measurements were made under the standardized environment of Refond.
6. Luminous intensity range is for reference only,specific parameters please refer to the label.

### 1.6 Typical optical characteristics curves

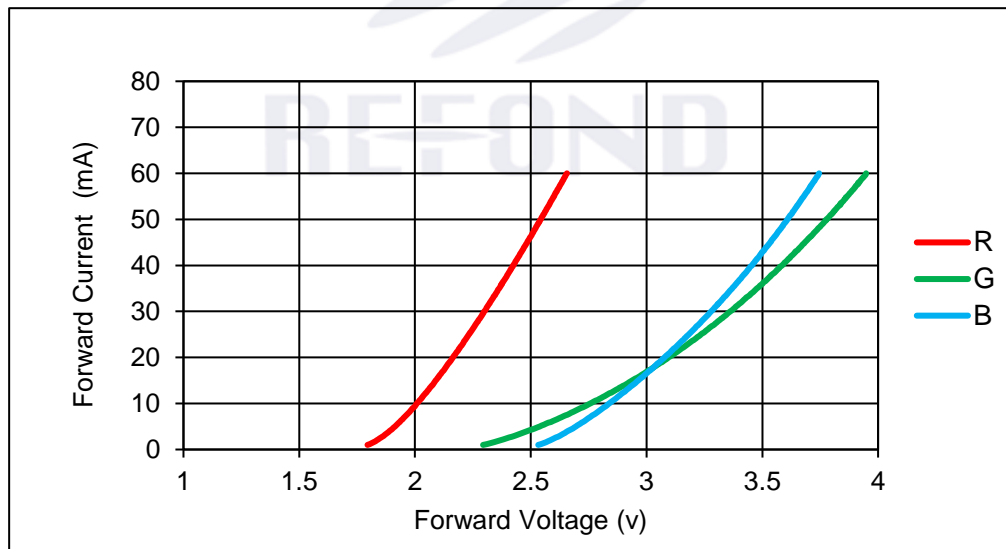

Fig 1-6 Forward Voltage Vs. Forward Current



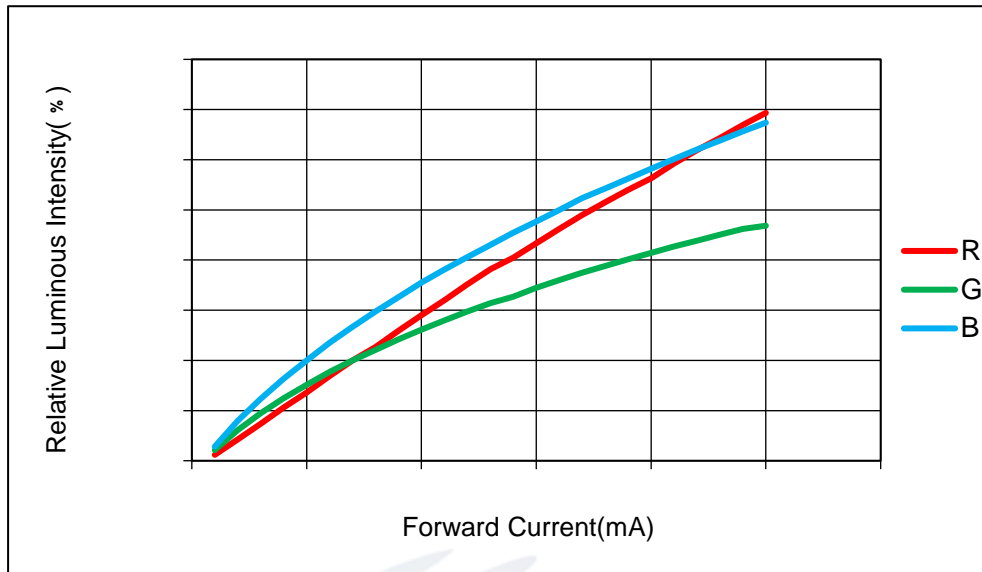

Fig 1-7 Forward Current Vs. Relative Intensity

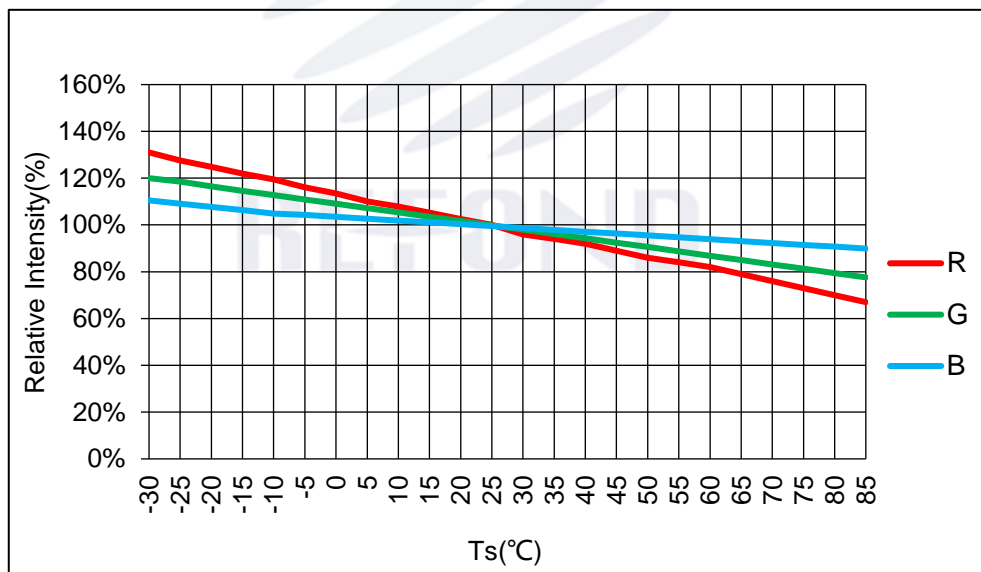

Fig 1-8 Luminous Intensity VS Ambient Temperature



Fig 1-9 Solder Temperature Vs Forward Current

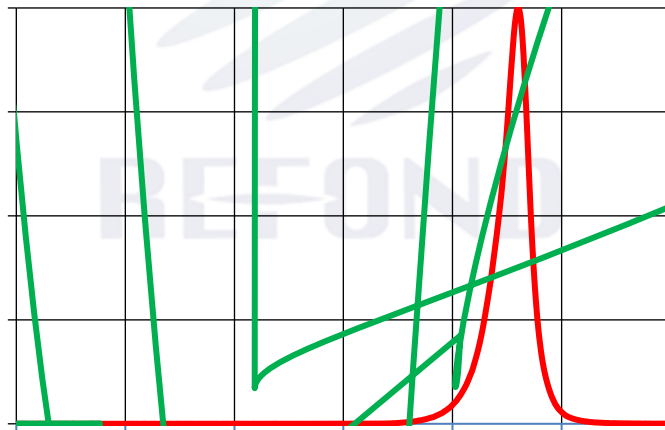

Fig 1-10 Spectrum Distribution



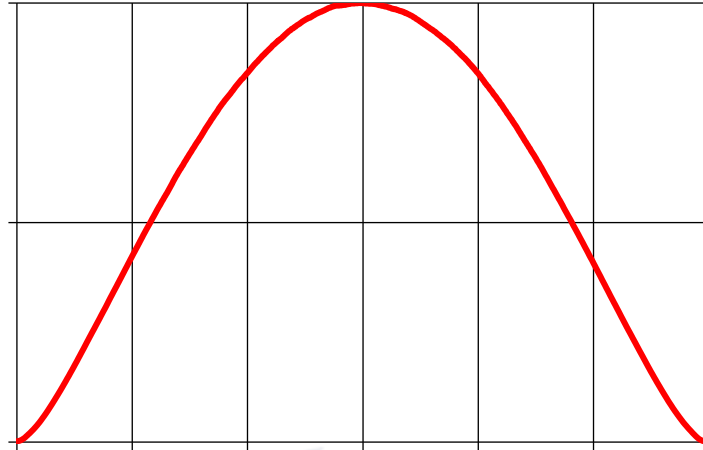

Fig 1-11 Directivity X-X radiation angle X

REFOND

Fig 1-12 Directivity Y-Y radiation angle Y



## 2. Packaging

### 2.1 Packaging Specification

Package:13000pcs/reel. 13000pcs

#### 2.1.1 Carrier Tape Dimension

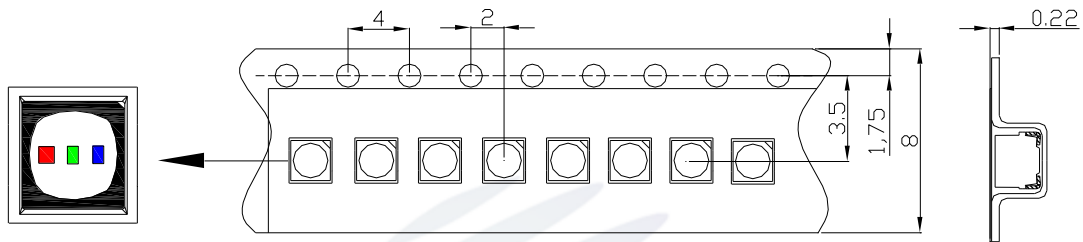

Fig.2-1 Carrier Tape Dimension

#### 2.1.2 Reel Dimension

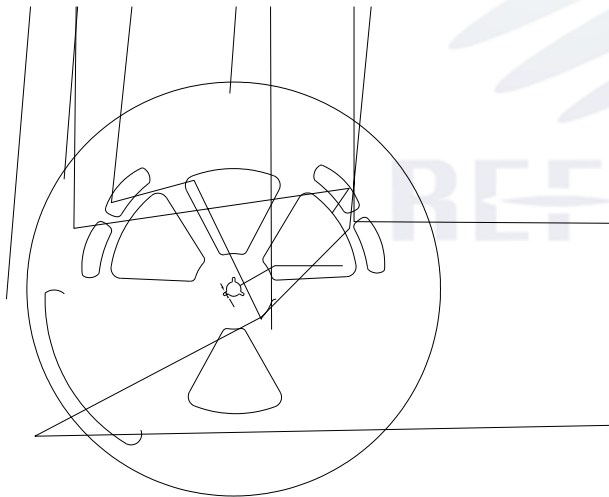

Fig.2-2 Reel

A	400 2mm
B	100.0 0.4mm
C	14.3 0.3mm
D	2.6 0.2mm
E	12.4 0.3mm
F	8.6 0.2/-0.3 mm
T	1.9 0.2mm

#### Notes

The tolerances unless mentioned  $\pm 0.1$ mm. Unit : mm 注：未注公差为 $\pm 0.1$ 毫米，尺寸单位：毫米



### 2.1.3 Label Form Specification

Table 2-2 Description

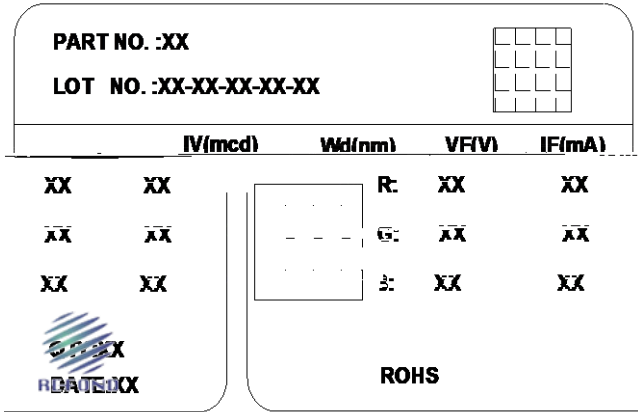

PART NO.	Part Number
LOT NO.	Lot Number + Packing Machine No. + Serial Number +BIN No. + Quantity (K)
	+ + +BIN + K
IV	Light intensity
VF	Forward Voltage
Wd	Wavelength
IF	Forward current
QTY	Packing Quantity
DATE	Made Date

Fig 2-3 Label

### 2.2 Moisture Resistant Packing

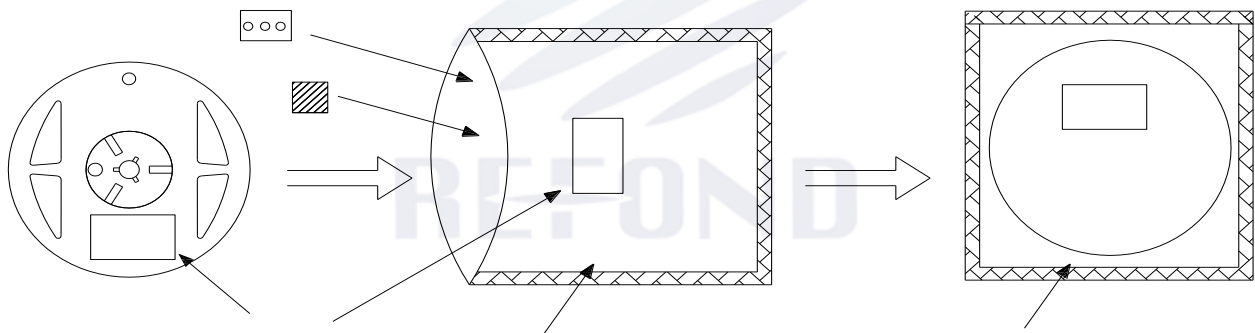

Fig.2-4 Pack



## 2.3 Cardboard Box

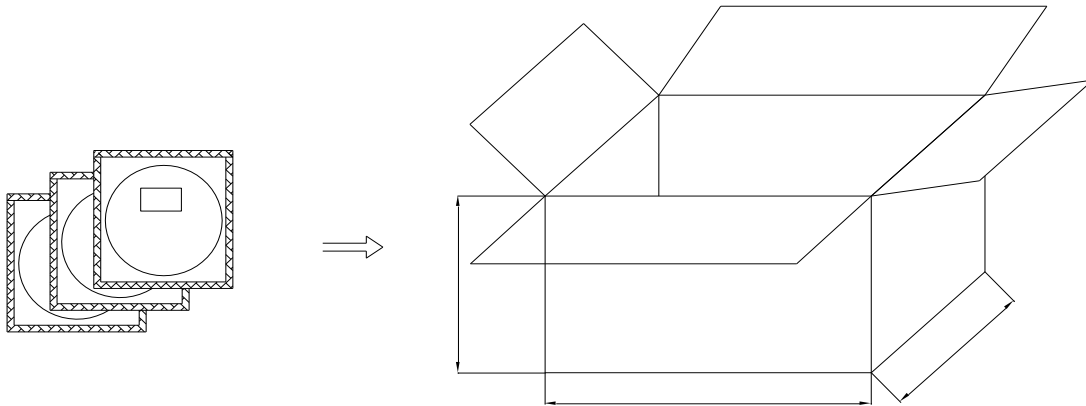
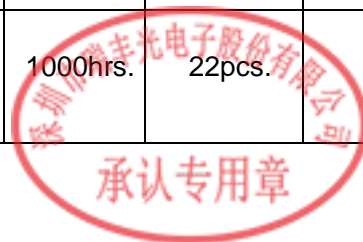

Fig.2-5 Box

## 2.4 Reliability Test Items And Conditions

Table 2-3 Reliability Condition

Test Items	Ref.Standard	Test Condition	Time	Quantity	Ac/Re /
Resistance to Soldering Heat	JESD22-B106	Temp:250 max T=10 sec	3times	22pcs.	0/1
Thermal Shock	JEITAED-4701 300 307	-40 15min 10s 100 15min	500cycle	22pcs.	0/1
Moisture Resistance	IPC/JEDEC J-STD-020D.1	1. Moisture Absorption Ta=85 / RH=85%/12HR 2. Tsol=250 , T=10s Reflow Soldering	3times	22pcs.	0/1
High Temperature Storage	JEITAED-4701 200 201	Temp:100	1000hrs.	22pcs.	0/1





Notes

The Reliability tests are based on Refond existing test platform.

2.The above reliability tests is based on the verification of a single/strip LED of Refond's existing experimental platform,the reliability experiment was taken under good heat dissipation conditions. when customers applies the LED to the series and parallel circuit,should take consideration of all the factors such as the current, voltage distribution, heat dissipation and others.

### 3. SMT Reflow Soldering Instructions SMT

#### 3.1 SMT Reflow Soldering Instructions SMT

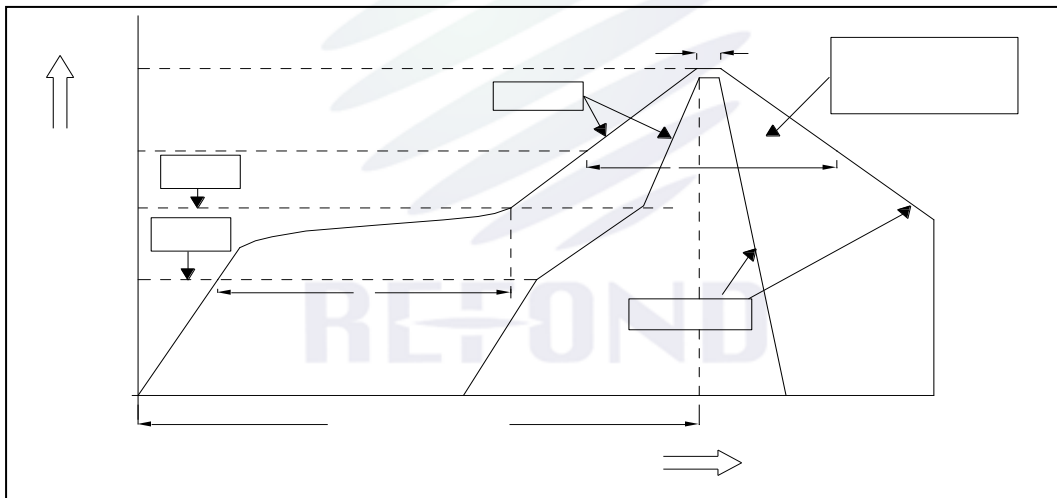

Fig.3-1 Profile





caused by heat or atmosphere.

6. This product can differ in optical characteristics depending on the number of reflow cycles. In a single display, only LEDs with same number of reflow cycles should be used regardless of the application type, such as rental and/or permanent installations.

7. This LED is designed to be reflow soldered on to a PCB. If dip soldered, cannot guarantee its reliability.

### 3.1.1 Soldering Iron

(1) When hand soldering, keep the temperature of iron below less 300°C less than 3 seconds

(2) The hand solder should be done only one time.

### 3.1.2 Repairing

Repair should not be done after the LEDs have been soldered. When repairing is unavoidable, a double-head soldering iron should be used (as below figure). It should be confirmed in advance whether the characteristics of LEDs will or will not be damaged by repairing.

LED

### 3.1.3 Cleaning

The LEDs should not be cleaned with water, benzene, and/or thinner.



## 4.Handling Precautions

### 4.1Handling Precautions

#### 4.1.1 Storage

(1) Moisture proof and anti-electrostatic package with moisture absorbent material is used, Suggest storage time is less than 6 months.

(2) Storage condition: temperature  $\leq 30^{\circ}\text{C}$ , humidity  $\leq 60\% \text{ RH}$ .

(3) Before opening the package, please check the package for air leaks, if there exists any air leaks, please return the product to our company for package after dehumidification by baking before your second use.

(4) After the package is opened, the product must be used in the specified environment of temperature below  $30^{\circ}\text{C}$ /humidity below  $60\% \text{ RH}$ , and soldered within 12HR. Unused material must be stored in the environment of temperature below  $30^{\circ}\text{C}$ /humidity below  $10\% \text{ RH}$ , These surplus products should be baked  $65 \pm 5^{\circ}\text{C}/24\text{H}$  before next use.

12 :30 :10%RH  
 :65 5 /24H

(5) Before SMT, LEDs need to be baked , baking requirement as below :



Customer pre-treatment conditions before use				
Condition before use	undamped Production date 2 months 2	undamped Production date 2-6 months 2-6	undamped Production date 6-12 months 6-12	damped or Production date exceed 12 months 12
Pre-treatment	Baked 65 5 /12H 65 5 /12H	Baked 65 5 /24H 65 5 /24H	Baked 65 5 /48H 65 5 /48H	Return to the original factory for processing

#### 4.1.2 Static Electricity

Static electricity and surge voltage damage the LEDs. Damaged LEDs will show some unusual characteristics such as the forward voltage becomes lower, or the LEDs do not light at the low current and even not light. All devices, equipment and machinery must be properly grounded. At the same time, it is also recommended that anti-electrostatic wrist bands, pads, uniforms, gloves or containers can be used as effective measures when dealing with the LEDs.

#### 4.1.3 Reverse voltage protection

In generally the reverse current of LED is very small, it can't effect using the component normally, but when it often suffered the reverse voltage which exceed the limits of the component than it will be damaged, the reverse current increases rapidly causing the string light display gray scale so when designing, please pay attention to control the reverse voltage we suggest the reverse voltage less than 5V.

LED ,  
 ,LED ,  
 , LED 5V.



#### 4.1.4 The safe temperature for LEDs working

(1) If the luminous intensity of LEDs decreased radically, if LEDs worked in hot environment for a long time, they will be disabled easily. When LEDs are working in hot environment, the surface temperature should be lower than 55°C and the ambient temperature should be lower than 75°C.

LED junction temperature, ambient temperature, surface temperature, 55°C, 75°C.

(2) Proper thermal management is an important when designing products with LEDs. LED die temperature is affected by PCB thermal resistance and LED spacing on the board. Please design products in a way that the LED die temperature does not exceed the maximum junction temperature (T<sub>J</sub>).

(3) Drive current should be determined for the surrounding ambient temperature (T<sub>A</sub>) to dissipate the heat from the product.

T<sub>A</sub>

#### 4.1.5 Directions for Use

(1) During designing a circuit, the current goes through each LED chip must not exceed the Absolute Max Rating current specified for each chip.

LED

(2) It is recommended that each LED chip is driven by a constant current.

LED

(3) When having the two or more dices within this product at the same time, the total power dissipation for the LED package must be within the max value specified in this specification.

LED

(4) This product should be operated with forward current. Make sure the product is not subjected to continuous reverse voltage because it may cause damage to the LED chip. If the display will not be



used for a long time, the main power should be switched off, Dehumidification is necessary before using the screen again.

## LED

(5) Make sure that the reverse voltage will not exceed the Absolute MaxRating when using the LEDs with matrix drive. Ensure that excessive voltages such as lightning surges are not applied to the LEDs.

## LED

## LED

(6) Aging is recommended in order to detect manufacturing and assembly defects. Particularly, make sure that excessive current and/or voltage is not applied to the LEDs. This aging should be conducted in environments where water condensation does not occur.

## LED

(7) when the LEDs are used in the following environments, incorporate sufficient measures into the display to prevent debris, water/moisture and gases that will adversely affect the product.

- where water vapor is abundant
- where water condensation is likely to occur
- where water is likely to splash onto the LEDs
- where frost is likely to form on the surface of the LEDs (e.g. freez2 842/F3( )μ3n9C.ice3n9C.sk-3(ti)10(o)

(8) In areas where hydrogen sulfide, which is a sulfide-based gas, is present (e.g. hot springs and volcanic areas), and where salt is abundant (e.g. coastal areas), the life may be shortened.

(9) When power has been applied to the LEDs for 100% wattage, the LEDs may have absorbed moisture. Before normal use of this display, operate the display at approximately 20% wattage for an initial time period.

LED	100
20	

(10) If the display units will be rented, those units should be selected carefully to ensure that the display as a whole will appear the same color and brightness.

(11) If the display modules are loaded onto and/or transported by ship, the moisture environment on the vessel can cause condensation; the display units should be packaged to prevent moisture absorption.

(12) If a display that has been, or is being, used is relocated, it is possible that degradation of the LED has occurred. When transporting this display, provide sufficient protection for the LEDs in addition to the moisture-proof packaging for the display. When this display is reinstalled, ensure to follow the installation instructions for environments and use.

LED	LED
LED	

#### 4.1.6 Others

(1) Do not directly touch or handle the epoxy surface. It may damage the internal circuitry. Handle the component along the side surfaces by using forceps or appropriate tools.



(2) Do not handle the LEDs with bare hands as it will contaminate the LED surface and may affect the optical characteristics: it might cause the LED to be deformed and/or the wire to break, which will cause the LED not to illuminate. The lead could also cause an injury.

LED

LED

LED

LED

(3) Do not stack assembled PCBs together. Otherwise, it may cause damage to the resin (e.g. cut, scratch, chip, crack, delamination and deformation) and the wire to break causing a catastrophic failure (i.e. the LED not to illuminate).

PCB

LED

(4) Other precautions, please refer to our "Ruifeng Photoelectric Full color SMD LED device User Manual".

SMD LED

#### 4.1.7 Declare

(1) This specification is written both in English and in Chinese and the latter is formal.

(2) Both the customers and Refond will agree on official specifications of supplied products before  
V X hidb Zgh da b Z egdY X dc l Z heZX XM dc h VaY dca ViZgWZh cZY 6cY GZ dcY  
reserves the right to further modify the specification for technical reference and sample without  
noticing the customers.







[www.refond.com](http://www.refond.com)



Declare

This specification is written both in English and in Chinese and the latter is formal.

