

Radiant Source Model Report



Source Description

Scan Environment

VALHGW () €
MAR €
& 0 VHG 00

(-)

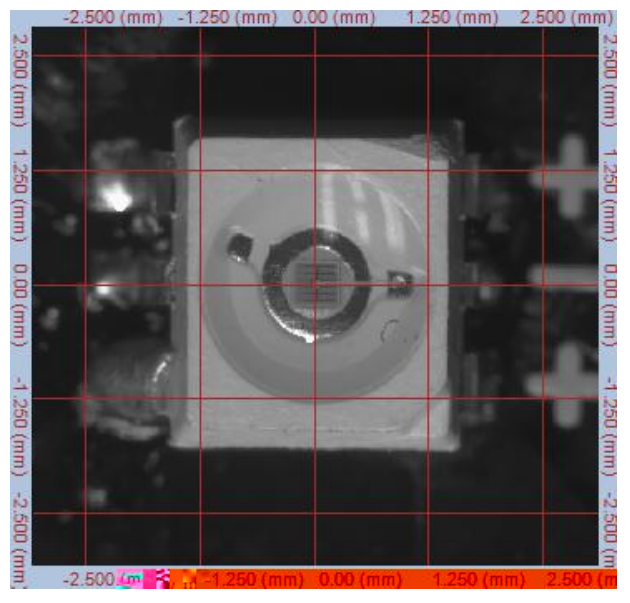
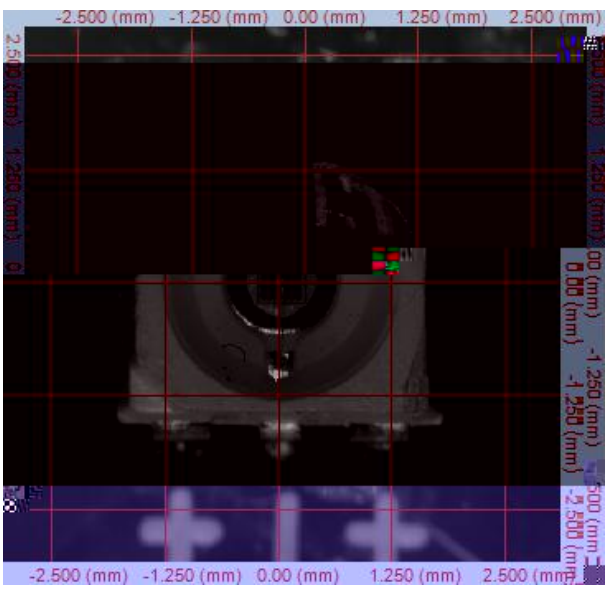

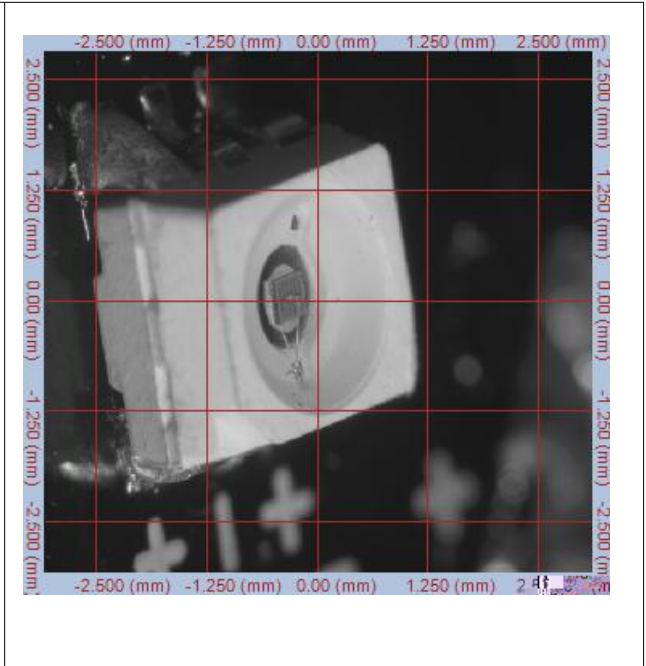
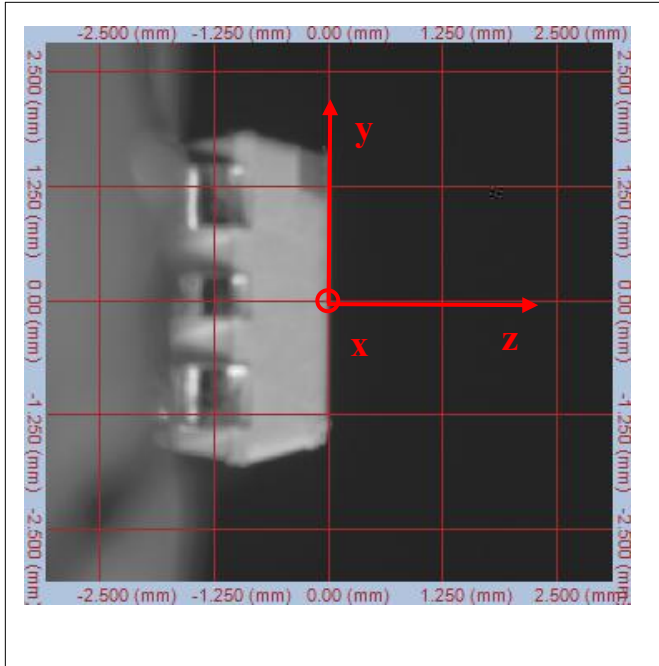

Top-View Luminance Image

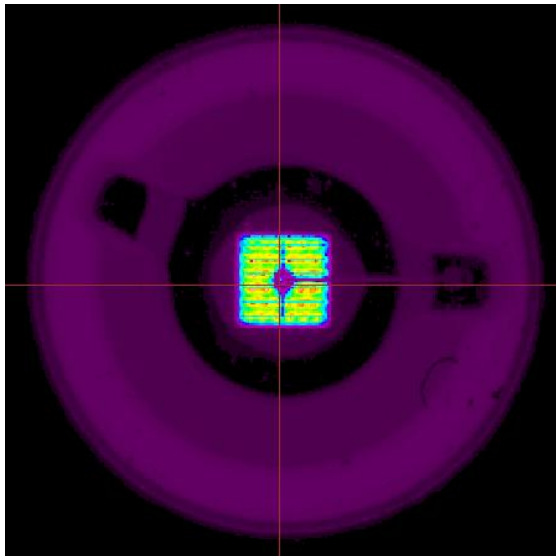

Intensity(traced to infinity)

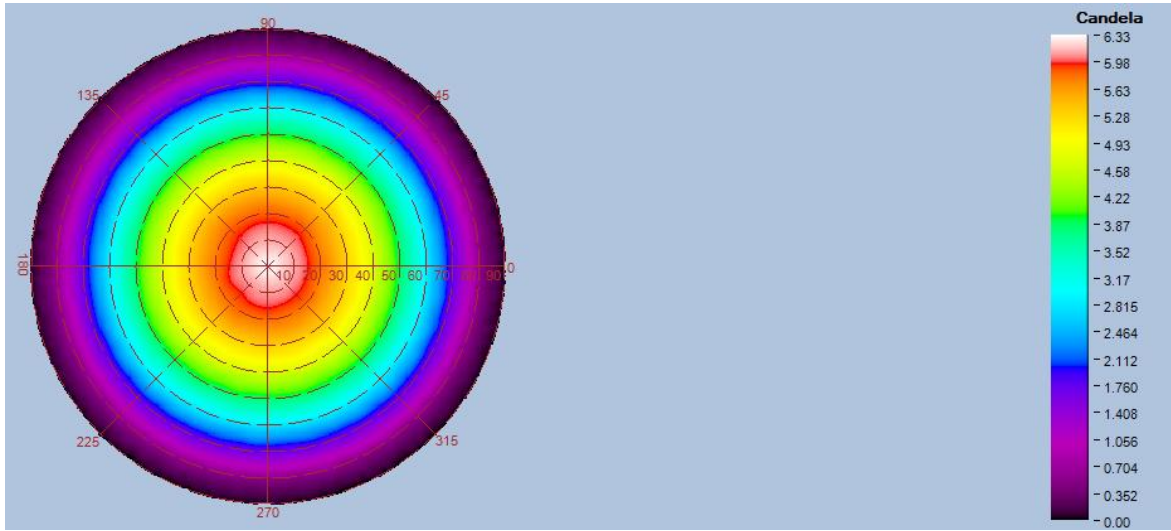

Intensity(traced to infinity) Cross Section Luminous Intensity(Candela)

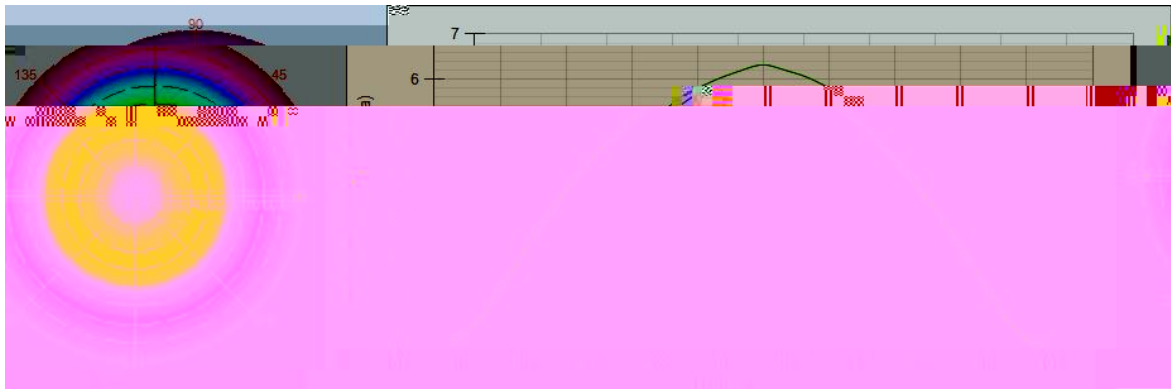

Intensity(traced to infinity) Cross Section Luminous Intensity(Candela)

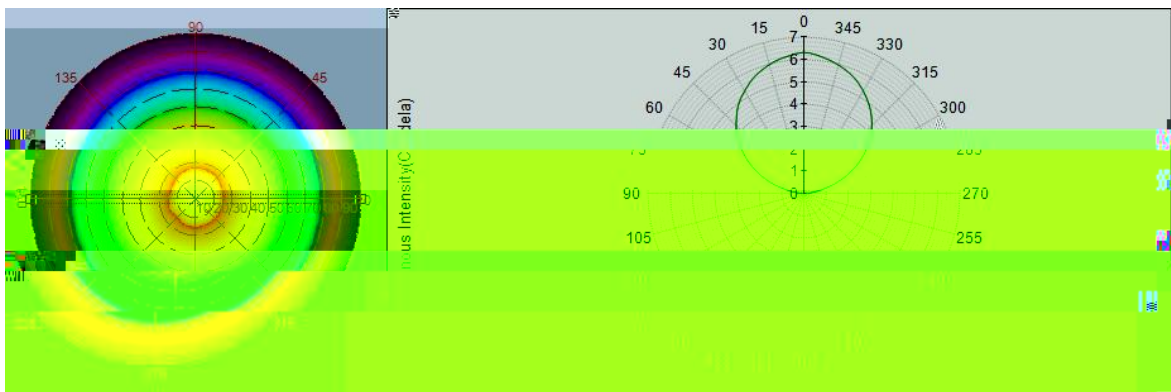

Intensity(traced to infinity) Iso-Plot

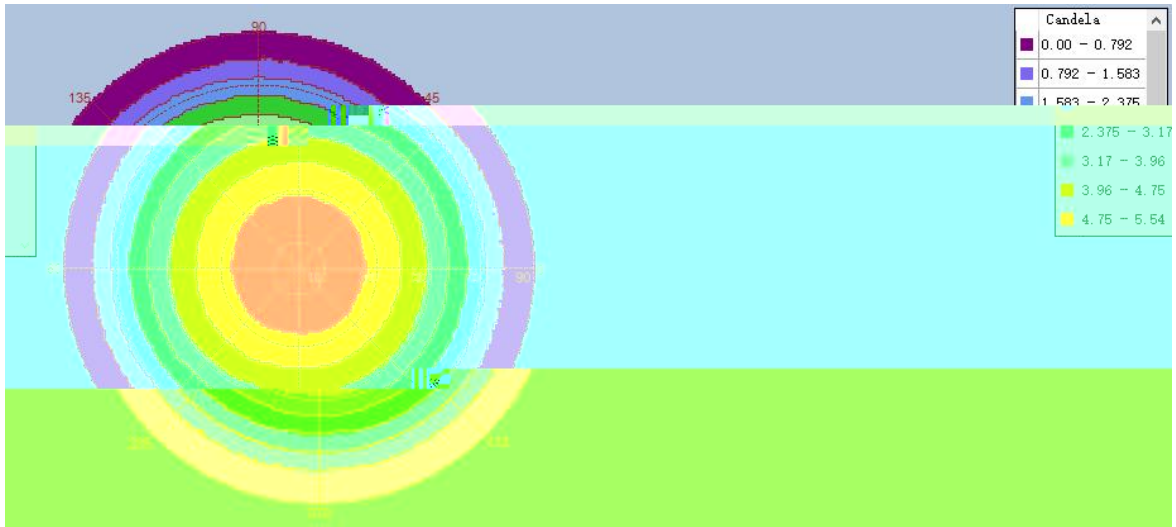

Intensity(traced to infinity) 3D Iso-Plot

