

ECIFICA I N





1. D

1.1 General Description

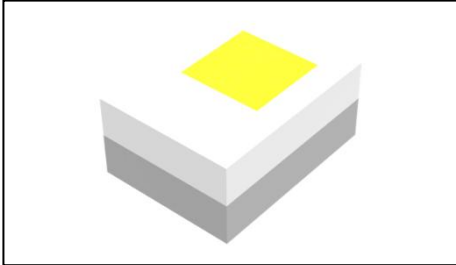

1.2 F

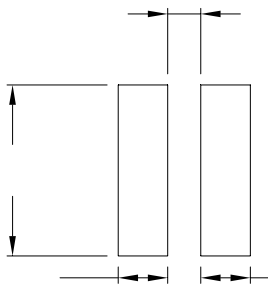
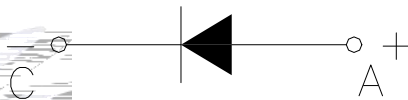
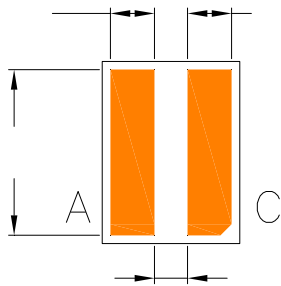
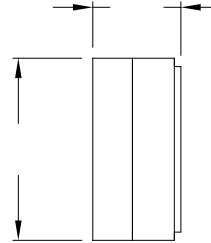
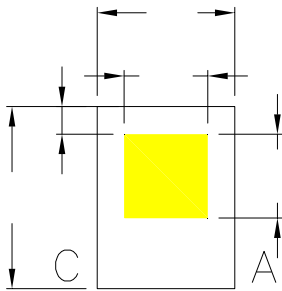

1.3 A

1.4 D

±



9.T



1.6 B F L F (IF=350 A)
 BIN (IF=350 A)

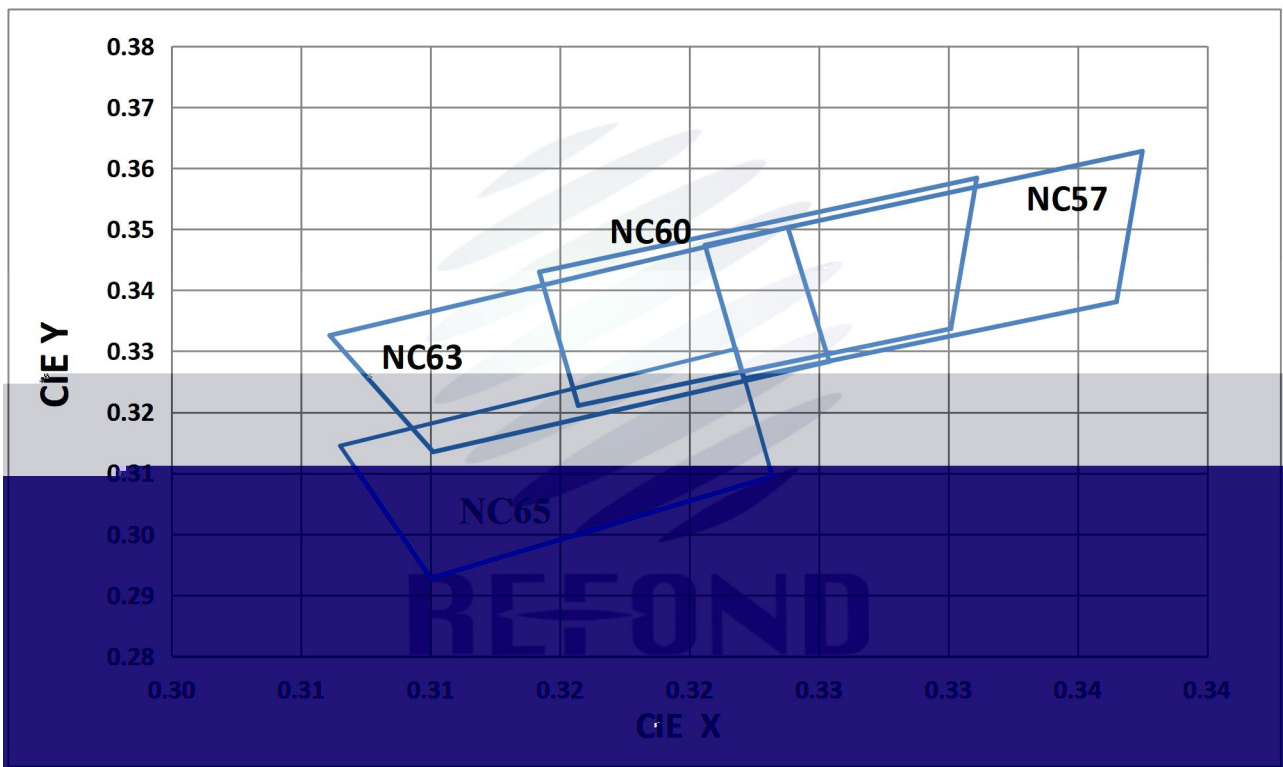

1.7

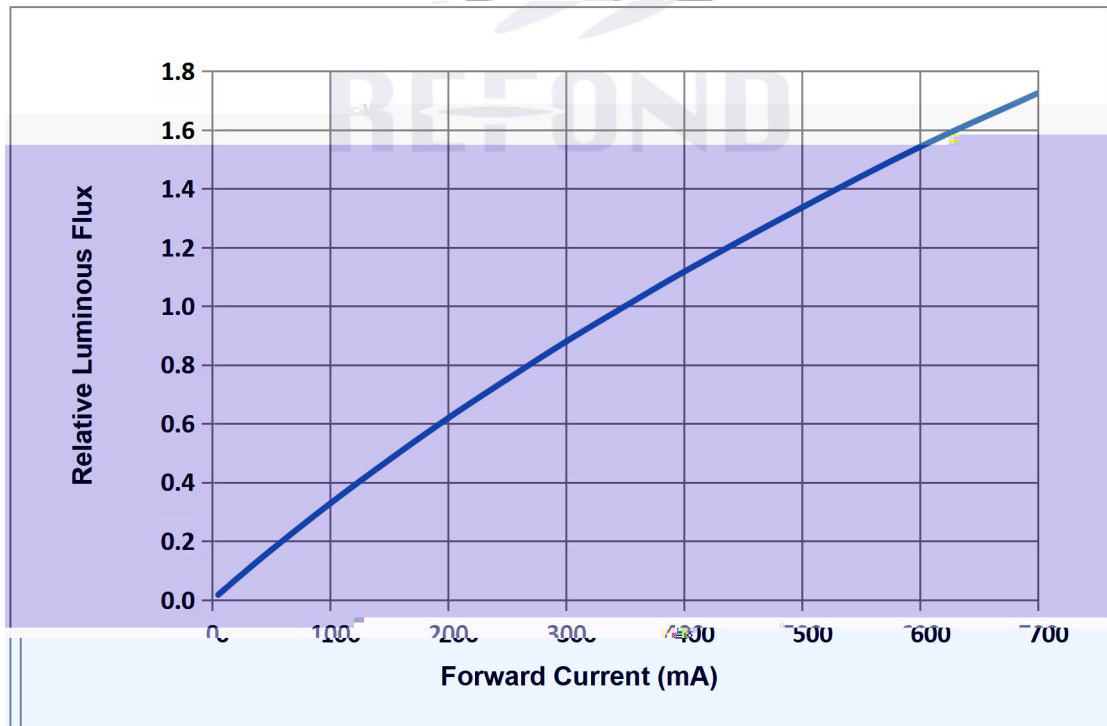
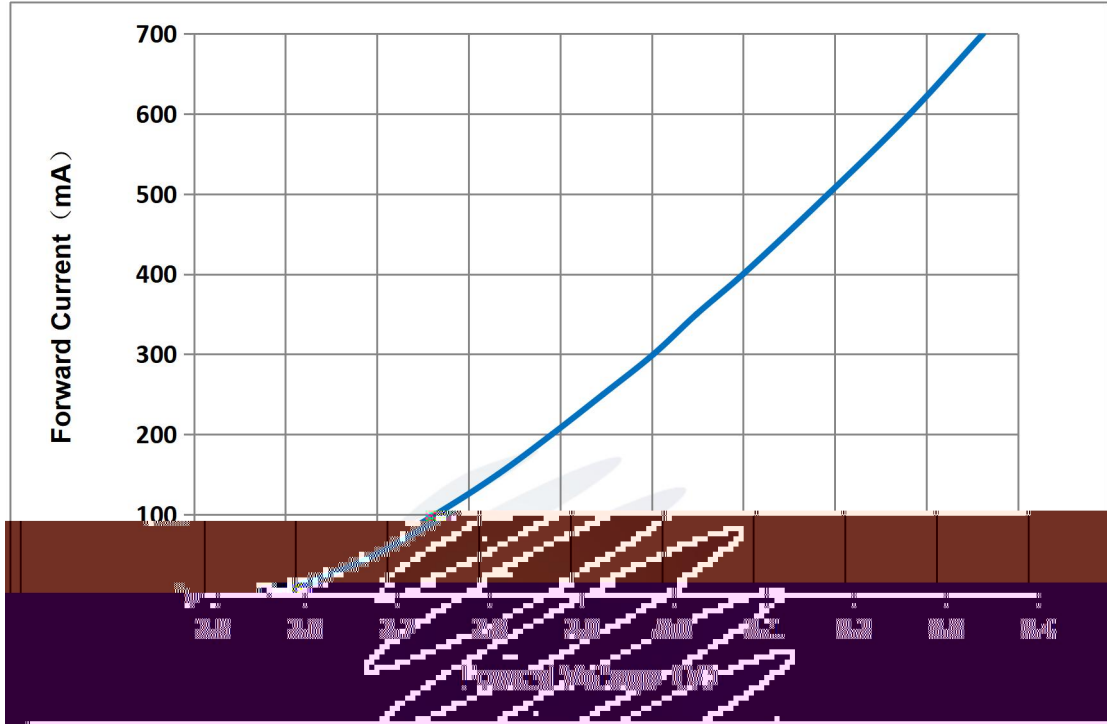

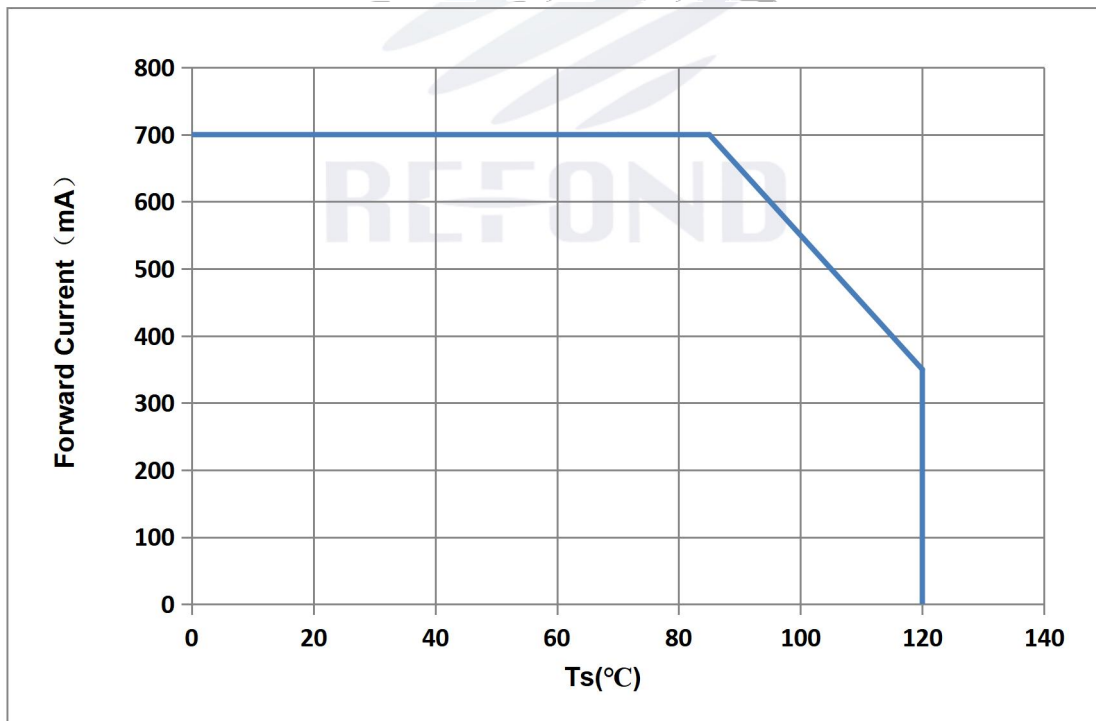
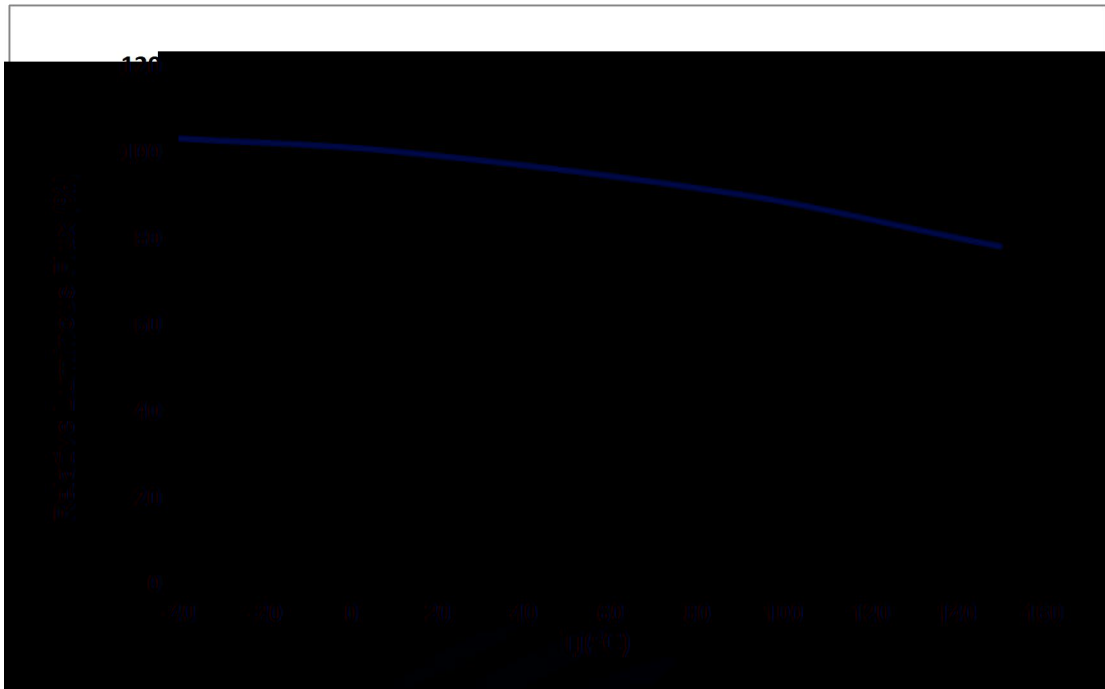

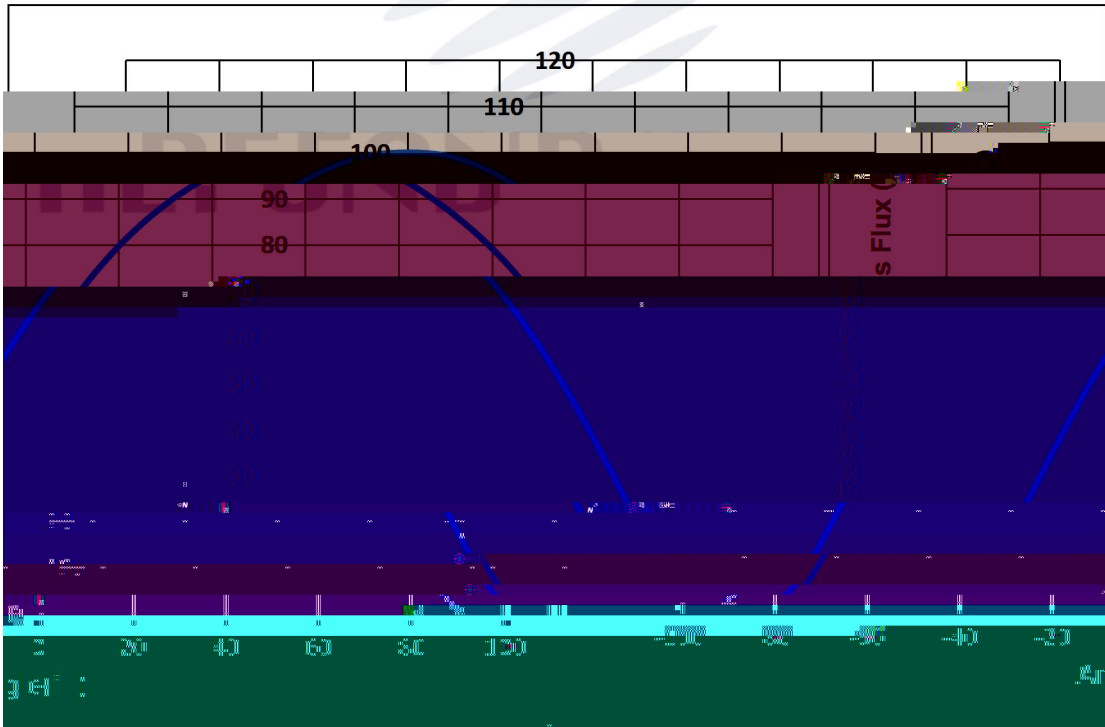
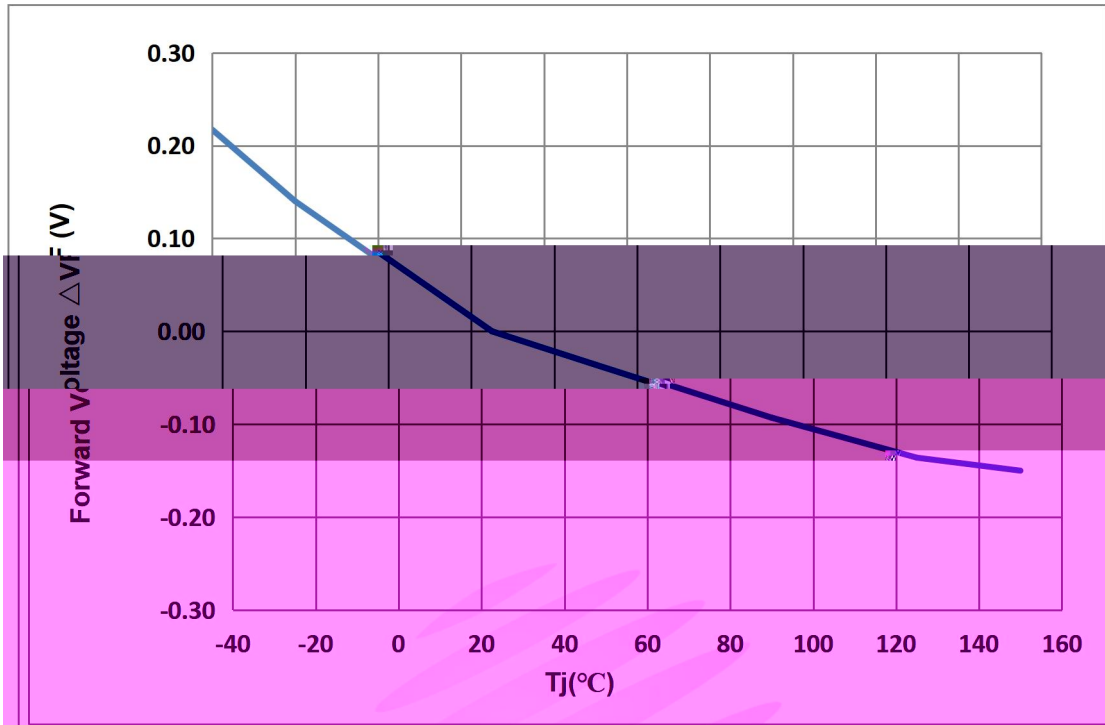

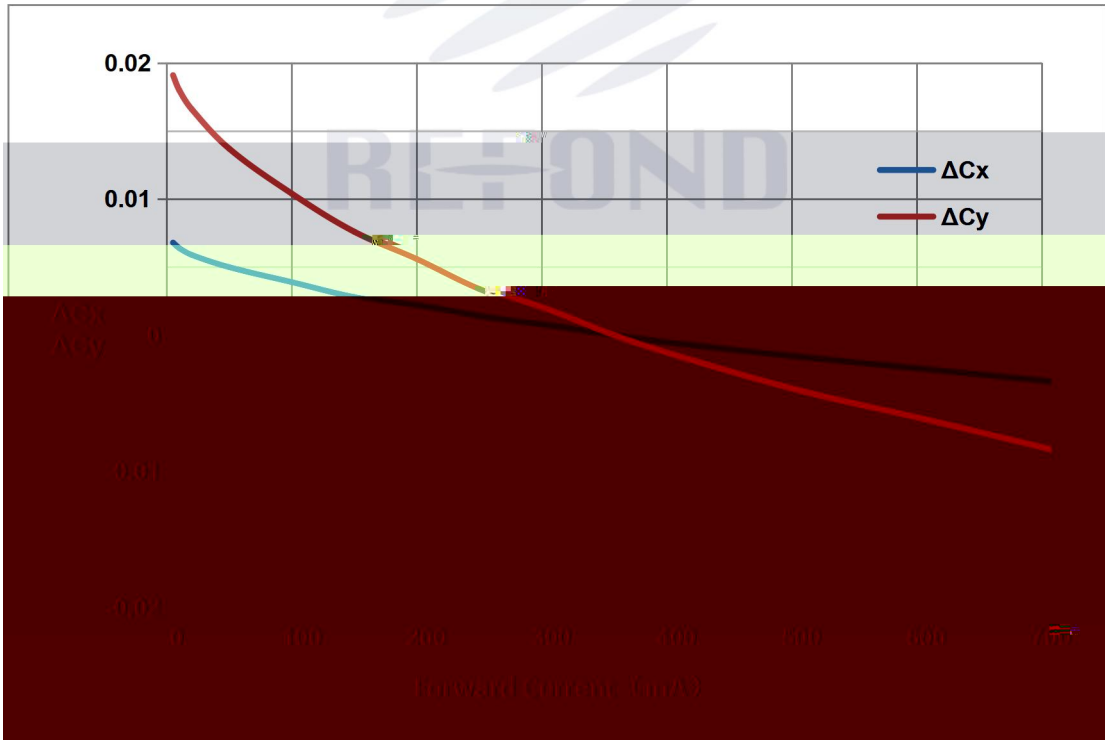
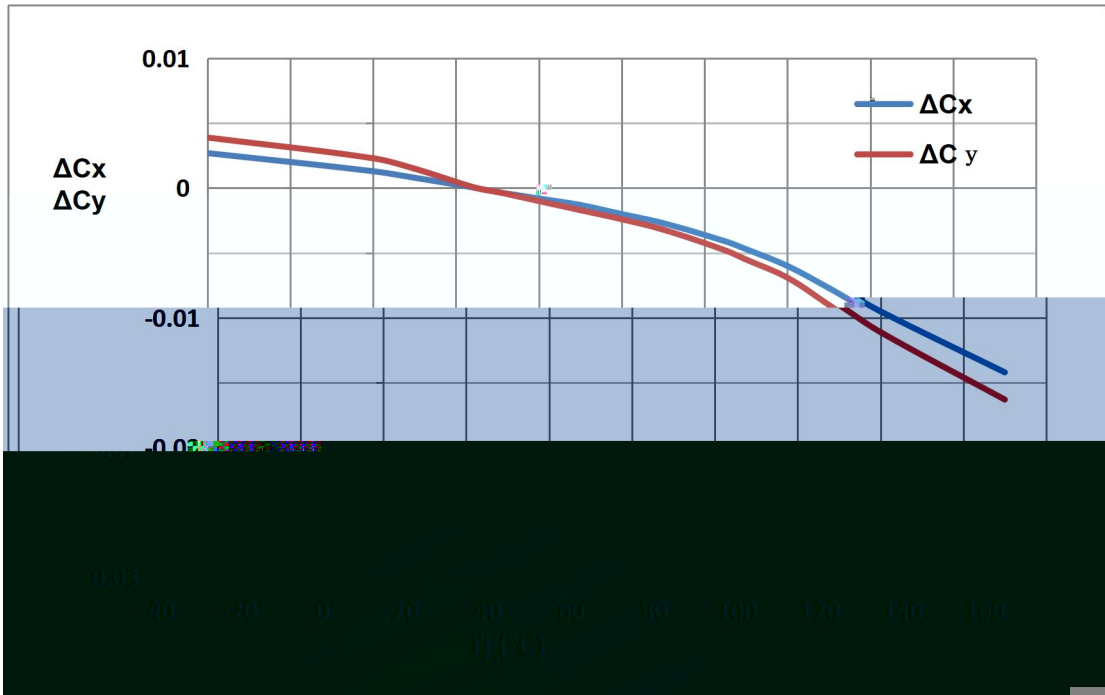

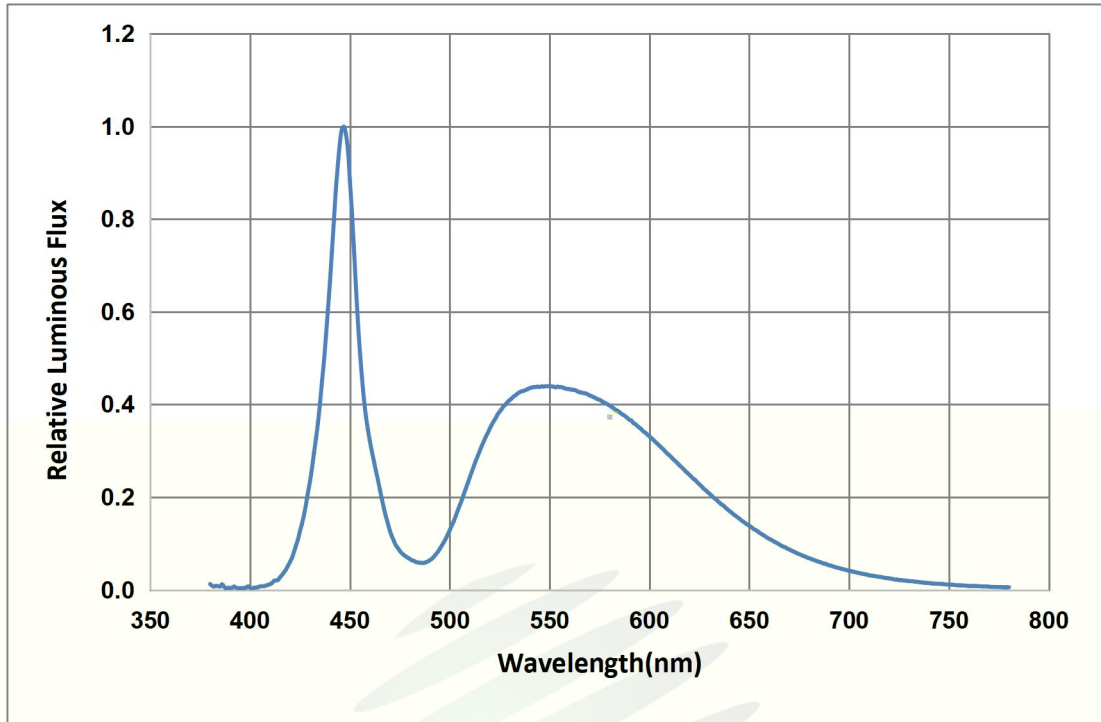

2.

2.1

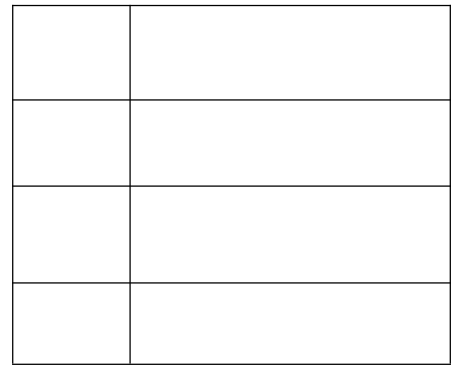
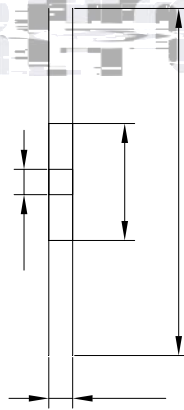
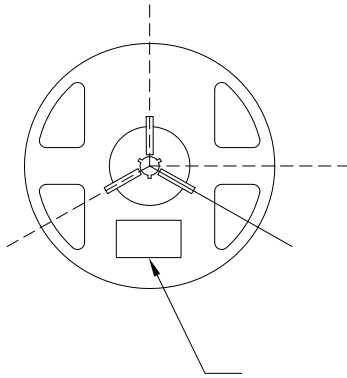
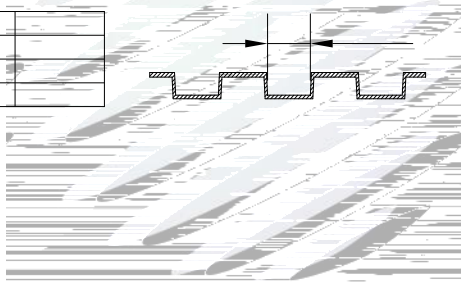
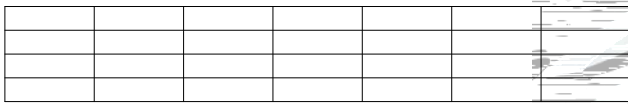
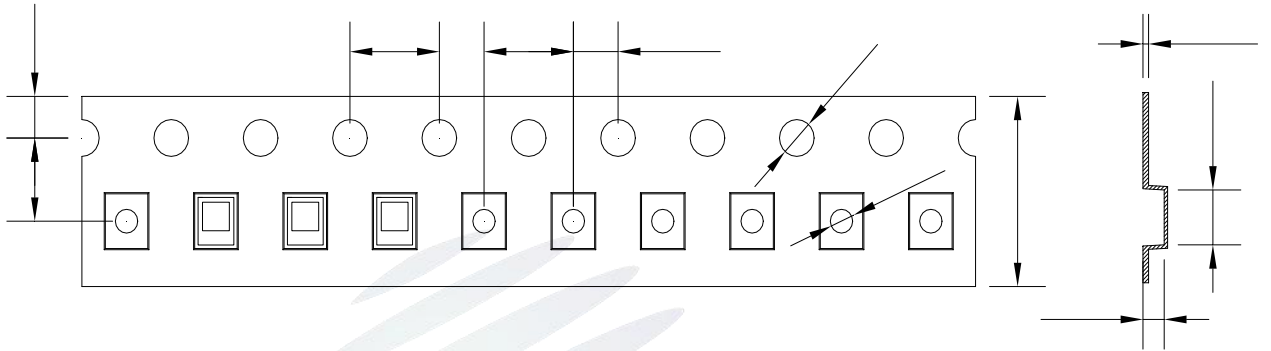



2.5 C F J D



3. M I M





4. H

4.1 H



 **BEYOND**

H

BEYOND

ଅନୁଷ୍ଠାନ

W

BEYOND

Innovation



