

TEST REPORT

:

:

:

:



Gold Medal Analytical & Testing Group

Applicant :

Address :

Sample Name : LED **Quantity** : 1pc **Sample Model** : RF-A4H11-WYSH-E

Receiving Date : 2024-12-09 **Test Date** : 2024-12-09 **Issued Date** : 2024-12-10

Environment : 20~25 /40~60%RH

Test Standard :

Requirements :

Test Address : 2

Remarks :

(Test Result)

4-8

| | | | | | |
|-----------------------|--|-----------------|--|-----------------|--|
| Main-Inspector | | Reviewer | | Approver | |
|-----------------------|--|-----------------|--|-----------------|--|

1.

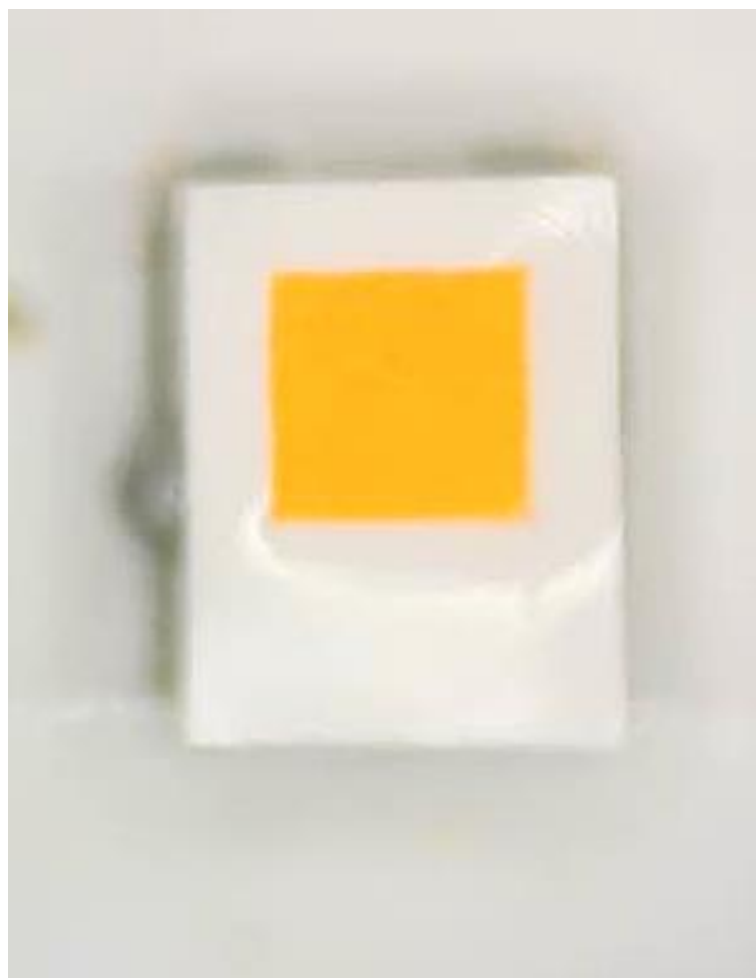
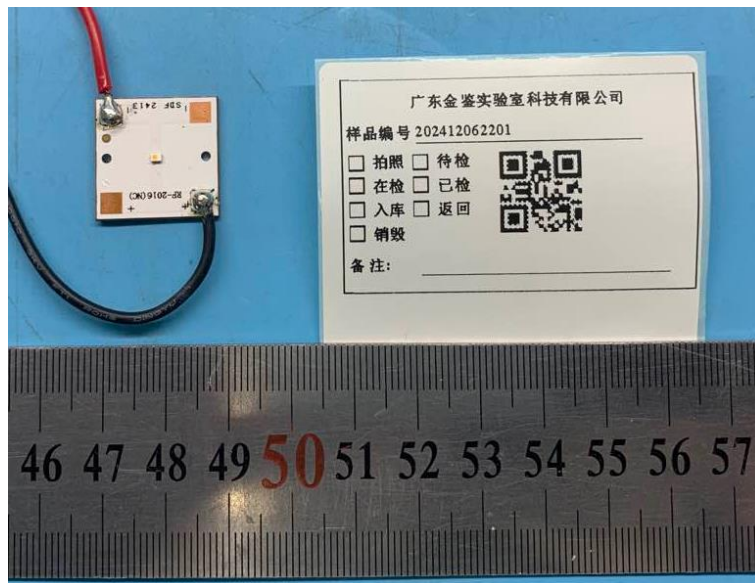

3.

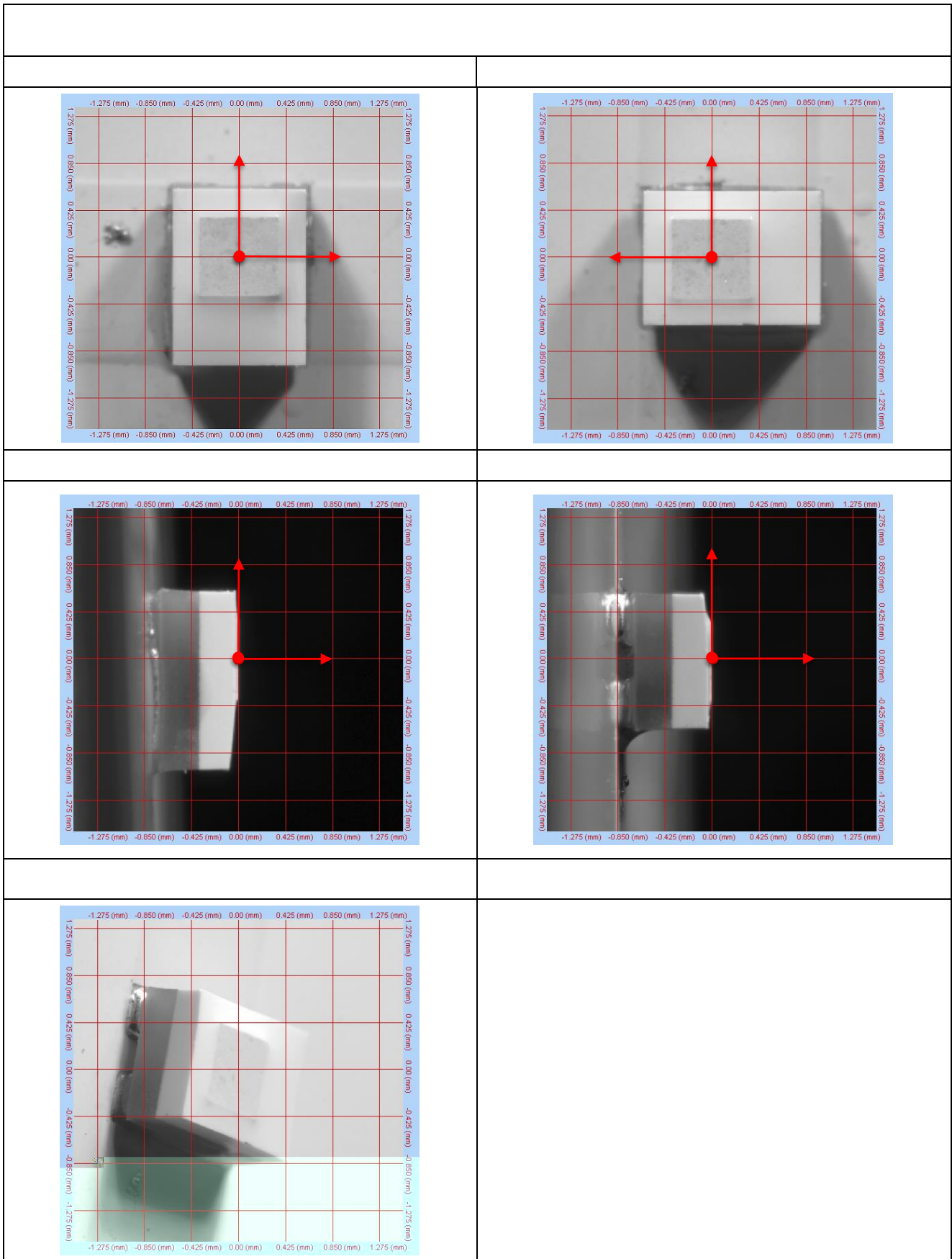

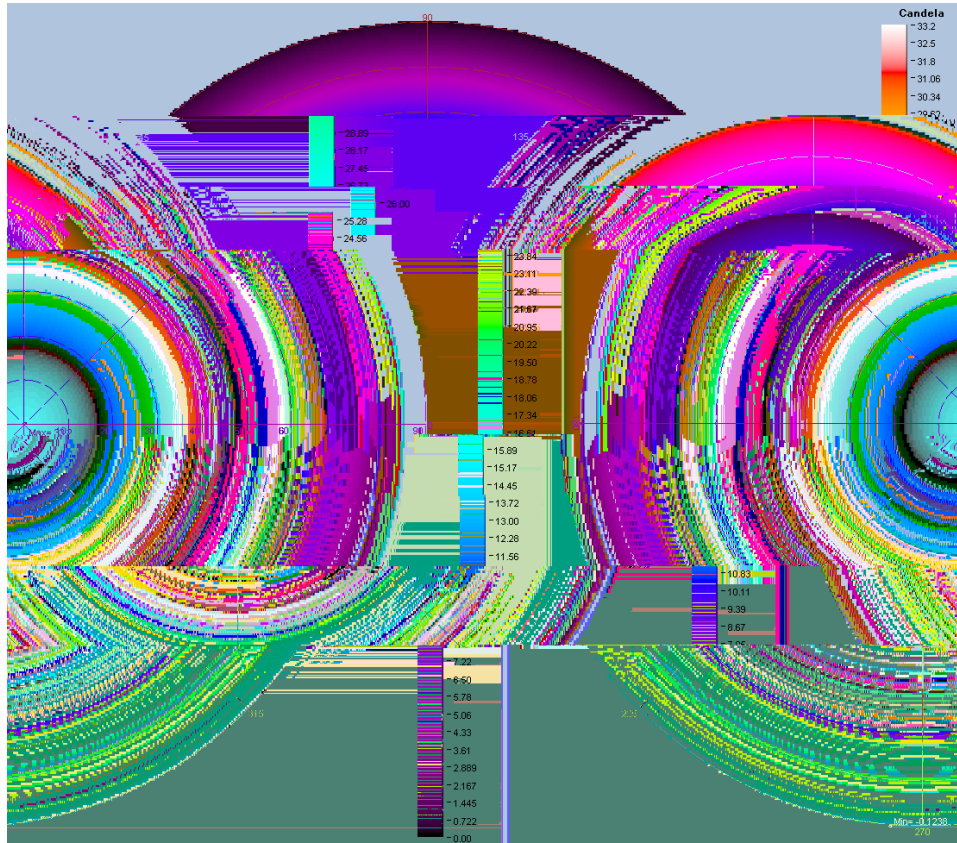

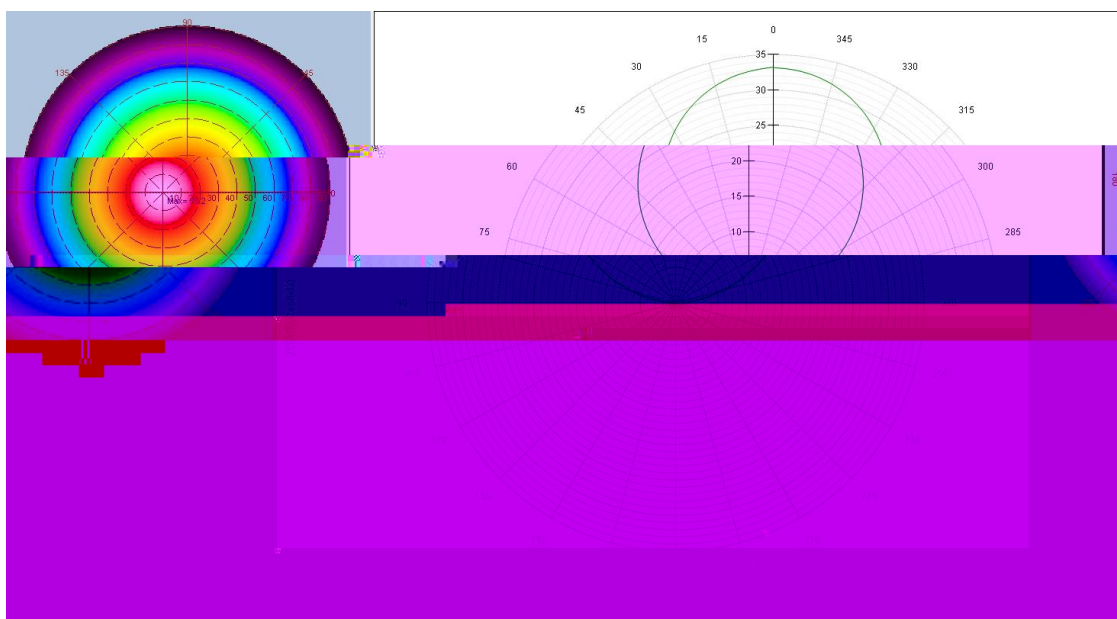
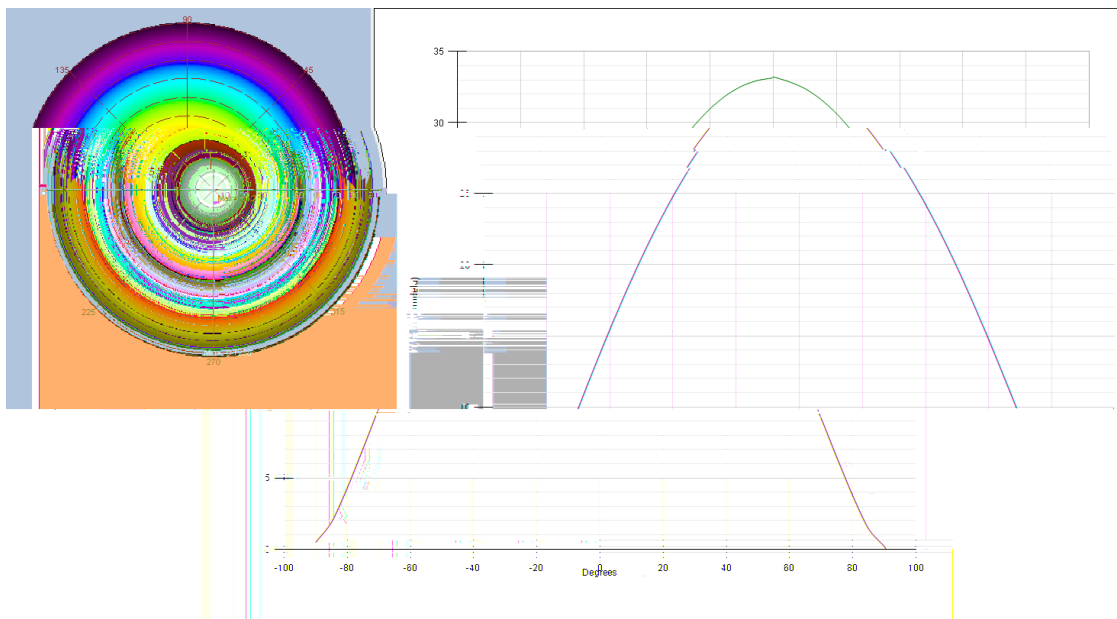

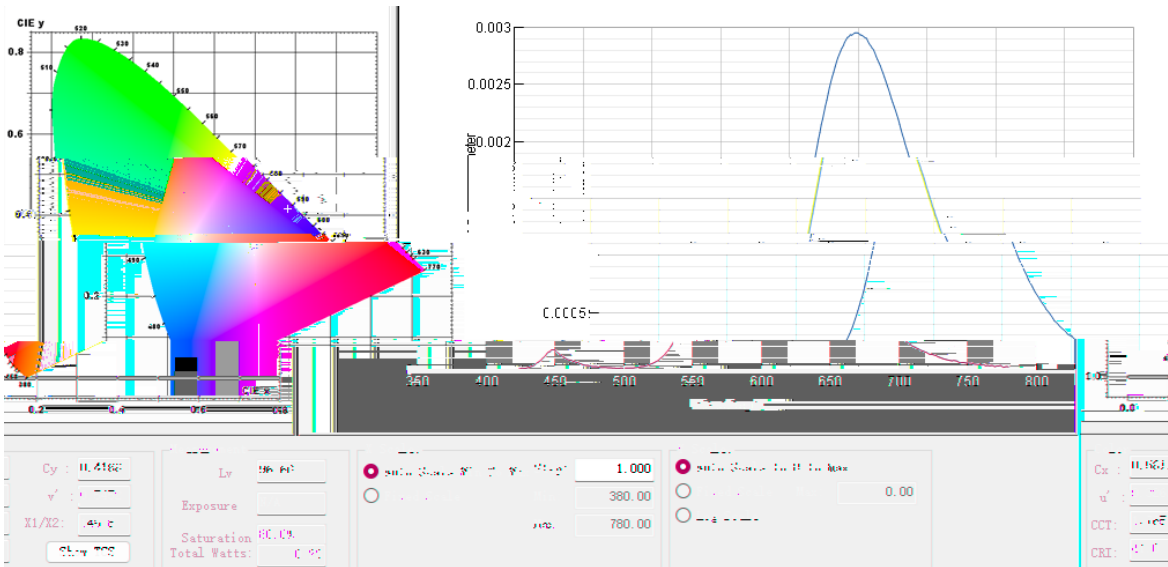
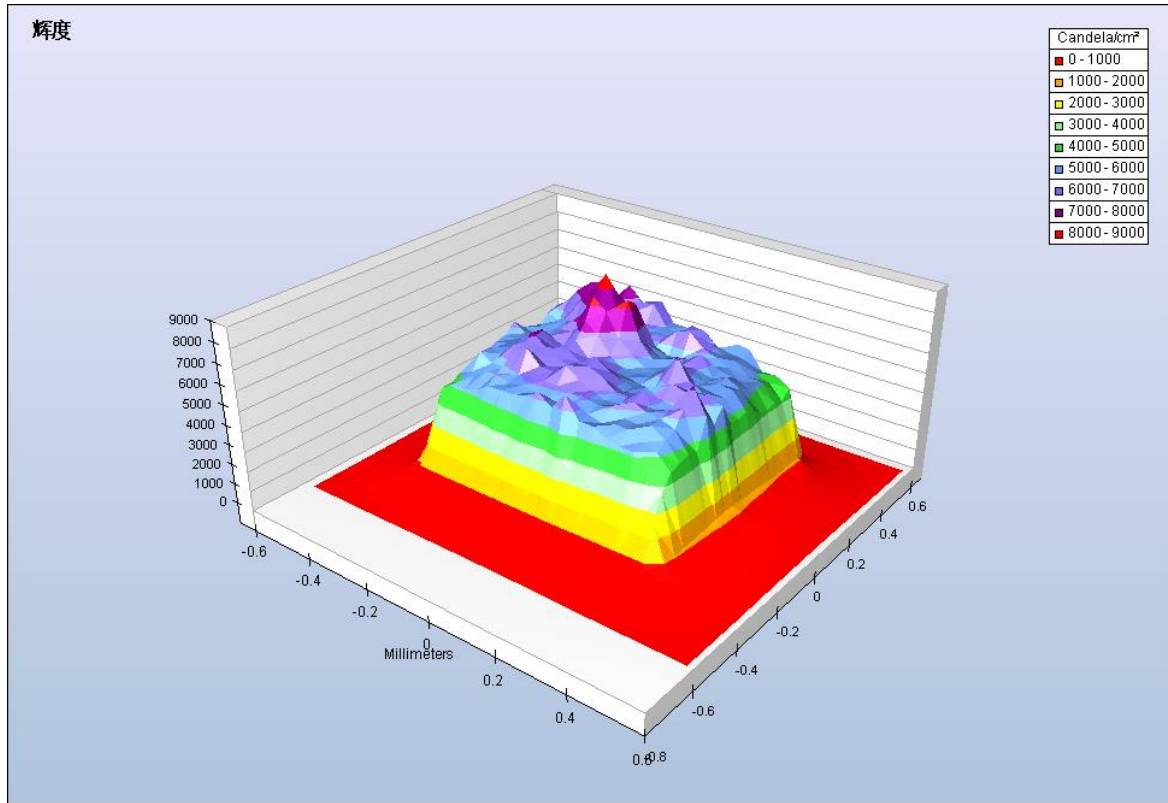

(Attention)

1.

2.

3.

4.

5.

6.

7.